

Smart Pump Range

Installation, operation
and maintenance manual



e-SVE

VME

e-HME

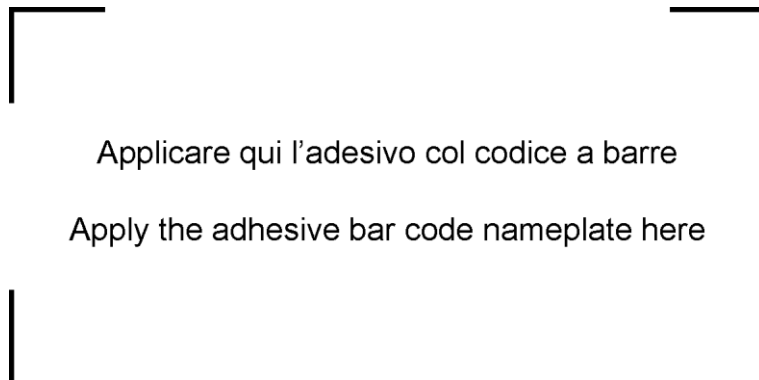

Applicare qui l'adesivo col codice a barre

Apply the adhesive bar code nameplate here



Table of Contents

1	Introduction and Safety	5
1.1	Introduction.....	5
1.2	Safety	5
1.2.1	Danger levels and safety symbols	5
1.2.2	User safety	6
1.2.3	General safety rules	7
1.2.4	Protection of the environment	8
1.2.5	Sites exposed to ionizing radiations	8
1.3	Spare parts.....	8
1.4	Product warranty	8
2	Transportation and Storage	9
2.1	Unit handling	9
2.2	Storage.....	10
3	Technical Description.....	11
3.1	Designation	11
3.2	Data plates	11
3.2.1	Motor	11
3.2.2	Pump.....	12
3.3	Design and layout.....	15
3.4	Intended use.....	16
3.4.1	Application alternatives	16
3.5	Improper use	16
4	Installation	17
4.1	Mechanical installation	17
4.1.1	Installation area	17
4.1.2	Unit installation	17
4.1.3	Outdoor unit installation	18
4.2	Hydraulic installation	19
4.3	Electrical Installation	20
4.3.1	Electrical requirements.....	20
4.3.2	Wire types and ratings.....	21
4.3.3	Power supply connection	22
5	Operation	25
5.1	Wait times.....	25
6	Programming	26
6.1	Control panel.....	26
6.2	Description of the buttons	27
6.3	LEDs description	27
6.3.1	POWER (power supply)	27

6.3.2	STATUS	27
6.3.3	SPEED (speed bar).....	27
6.3.4	COM (communication)	28
6.3.5	Unit of measurement.....	28
6.4	Display.....	29
6.4.1	Main visualization	29
6.4.2	Parameters menu visualization	29
6.4.3	Alarms and errors visualization	30
6.5	Software parameters	30
6.5.1	Status Parameters.....	31
6.5.2	Settings Parameters.....	32
6.5.3	Drive Configuration Parameters.....	32
6.5.4	Sensor Configuration Parameters.....	35
6.5.5	RS485 Interface Parameters.....	36
6.5.6	Multi-pump configuration parameters.....	36
6.5.7	Test Run Configuration Parameters.....	37
6.5.8	Special Parameters	37
6.6	Technical references	38
6.6.1	Example: ACT control mode with analog 0-10V input	38
6.6.2	Example: Ramp Settings.....	39
6.6.3	Example: Effective Required Value.....	39
7	Maintenance	41
8	Troubleshooting	42
8.1	Alarm codes	42
8.2	Error codes.....	42
9	Technical Data	44
9.1	Dimensions and weights	45
10	Declarations	47
10.1	EC Declaration of Conformity (Original).....	47
10.2	EU Declaration of Conformity (No EMCD19).....	47

1 Introduction and Safety



1.1 Introduction

Purpose of this manual

The purpose of this manual is to provide necessary information for:

- Installation
- Operation
- Maintenance



CAUTION:

Before installing and using the product, make sure that you read and fully understand this manual in all its parts. Improper use of the product can cause personal injuries and damage to property, as well as making the warranty null and void.

NOTICE:

This manual is an integral part of the product. It must always be made available to the user, stored in the proximity of the product, and well kept.



1.2 Safety

1.2.1 Danger levels and safety symbols

Before using the product, and in order to avoid the following risks, make sure that you carefully read, understand and comply with the following danger warnings:







- Injuries and health hazards
- Damage to the product
- Product malfunction.

Hazard levels



Hazard level	Indication
 DANGER:	It identifies a dangerous situation which, if not avoided, causes serious injury, or even death.
 WARNING:	It identifies a dangerous situation which, if not avoided, may cause serious injury, or even death.
 CAUTION:	It identifies a dangerous situation which, if not avoided, may cause small or medium level injuries.
NOTICE:	It identifies a situation which, if not avoided, may cause damage to property but not to people.

Special symbols

Some hazard categories have specific symbols, as shown in the following table:

Symbol	Description
	Electrical hazard
	Magnetic hazard
	Hot surface hazard
	Ionizing radiation hazard
	Potentially explosive atmosphere hazard (ATEX EU Directive)
	Cut and abrasion hazard
	Crushing hazard (limbs)

Other symbols

Symbol	Description
	User Specific information for the users of the product.
	Installer / Maintenance technician Specific information for personnel responsible for the installation of the product within the system (hydraulic and/or electric system), and for maintenance operations.

1.2.2 User safety

Strictly comply with current health and safety regulations.



WARNING:

This product must be used only by qualified users.

For the purposes of this manual, in addition to the provisions of any local regulations, qualified personnel means any individuals who, due to their experience or training, are capable of recognising any existing hazards and to avoiding dangers during the installation, the use and the maintenance of the product.

Inexperienced users**WARNING:****FOR THE EUROPEAN UNION**

- This appliance can be used by children aged from 8 years and above and persons with reduced physical, sensory or mental capabilities or lack of experience and knowledge if they have been given supervision or instruction concerning use of the appliance in a safe way and understand the hazards involved.
- Children shall not play with the appliance.
- Cleaning and user maintenance shall not be made by children without supervision.

FOR OTHER COUNTRIES

- This appliance is not intended for use by persons (including children) with reduced physical, sensory or mental capabilities, or lack of experience and knowledge, unless they have been given supervision or instruction concerning use of the appliance by a person responsible for their safety.
- Children should be supervised to ensure that they do not play with the appliance.

1.2.3 General safety rules**WARNING:**

- Always keep the work area clean.
- Pay attention to the risks presented by gas and vapors in the work area.
- Always bear in mind the risk of drowning, electrical accidents, and burn injuries.

**DANGER: Electrical hazard**

- Avoid all electric dangers; pay attention to the risk of electric shock or electric arcs
- Unintended rotation of motors creates voltage and can charge the unit, resulting in death, serious injury, or equipment damage. Ensure that motors are blocked to prevent unintended rotation.

Magnetic fields

The removal or installation of the rotor in the motor casing generates a strong magnetic field.

**DANGER: Magnetic hazard**

The magnetic field may be dangerous for anyone wearing pacemakers, or any other medical devices sensitive to magnetic fields.

NOTE

The magnetic field may attract metal debris on the rotor surface, causing damage to the same.

Electrical connections**DANGER: Electrical hazard**

- The connection to the electric power supply must be completed by an electrician possessing the technical-professional requirements outlined in the current regulations

Precautions before work**WARNING:**

- Install a suitable barrier around the working area, for example a guard rail
- Make sure that all safety guards are in place and secure.
- Make sure that you have a clear path of retreat.
- Make sure that the product cannot roll or fall over and injure people or damage property.
- Make sure that the lifting equipment is in good condition.
- Use a lifting harness, a safety line, and a breathing device as required.

- Allow all pump system components to cool before handling them
- Make sure that the product has been thoroughly cleaned
- Disconnect and lock out power before you service the pump.
- Check the explosion risk before you weld or use electric hand tools.

Precautions during work



WARNING:

- Never work alone.
- Always wear personal protective equipment
- Always use suitable working tools
- Always lift the product by its lifting device.
- Stay clear of suspended loads.
- Beware of the risk of a sudden start if the product is used with an automatic level control.
- Beware of the starting jerk, which can be powerful.
- Rinse the components in water after you disassemble the pump.
- Do not exceed the maximum working pressure of the pump.
- Do not open any vent or drain valve or remove any plugs while the system is pressurized.
- Make sure that the pump is isolated from the system and that all pressure is released before disassembling the pump, removing plugs, or disconnecting the piping
- Never operate the pump without a properly installed coupling guard.

In case of contact with chemical substances or dangerous liquids

Follow these procedures for chemicals or hazardous fluids that have come into contact with your eyes or your skin:

Condition	Action
Chemicals or hazardous fluids in eyes	<ol style="list-style-type: none"> 1. Hold your eyelids apart forcibly with your fingers. 2. Rinse the eyes with eyewash or running water for at least 15 min. 3. Seek medical attention.
Chemicals or hazardous fluids on skin	<ol style="list-style-type: none"> 1. Remove contaminated clothing. 2. Wash the skin with soap and water for at least 1 min. 3. Seek medical attention, if necessary.

1.2.4 Protection of the environment

Disposal of packaging and product

Comply with the current regulations on sorted waste disposal.

1.2.5 Sites exposed to ionizing radiations



WARNING: Ionizing radiation hazard

If the product has been exposed to ionizing radiations, implement the necessary safety measures for the protection of people. If the product needs to be despatched, inform the carrier and the recipient accordingly, so that appropriate safety measures can be put in place.

1.3 Spare parts

When contacting Xylem or the Authorised Distributor to request technical information or spare parts, always indicate the product type and code.

1.4 Product warranty

For information on the warranty refer to the documentation of the sale contract.

2 Transportation and Storage



Packaging inspection

1. Check that quantity, descriptions and product codes match the order.
 2. Check the packaging for any damage or missing components.
 3. In case of immediately detectable damage or missing parts:
 - Accept the goods with reserve, indicating any findings on the transport document, or
 - Reject the goods, indicating the reason on the transport document.
- In both cases, promptly contact Xylem or the Authorised Distributor from whom the product was purchased.

Unpacking and inspection of the unit

1. Remove packing materials from the product.
2. Release the product by removing the screws and/or cutting the straps, if fitted.



CAUTION: Cut and abrasion hazard

Always wear personal protective equipment.

3. Check the product for integrity and to make sure that there are no missing components.
4. In case of damage or missing components, promptly contact Xylem or the Authorised Distributor.

2.1 Unit handling

The unit must be harnessed and lifted as shown in Figure 1.



WARNING: Crushing hazard (limbs)

- The product and its components may be heavy: risk of crushing
 - Always wear personal protective equipment
 - Manual handling of the product and its components must be in compliance with the current regulations on "manual load handling", to avoid unfavourable ergonomic conditions causing risks of back-spine injury.
 - Use cranes, ropes, lifting straps, hooks and clasps that comply with current regulations and that are suitable for the specific use
 - Make sure that the harnessing does not damage the unit
 - During the lifting operations, always avoid sudden movements that could compromise the stability of the load
 - During handling, make sure to avoid injury to people and animals, and/or damage to property.
-

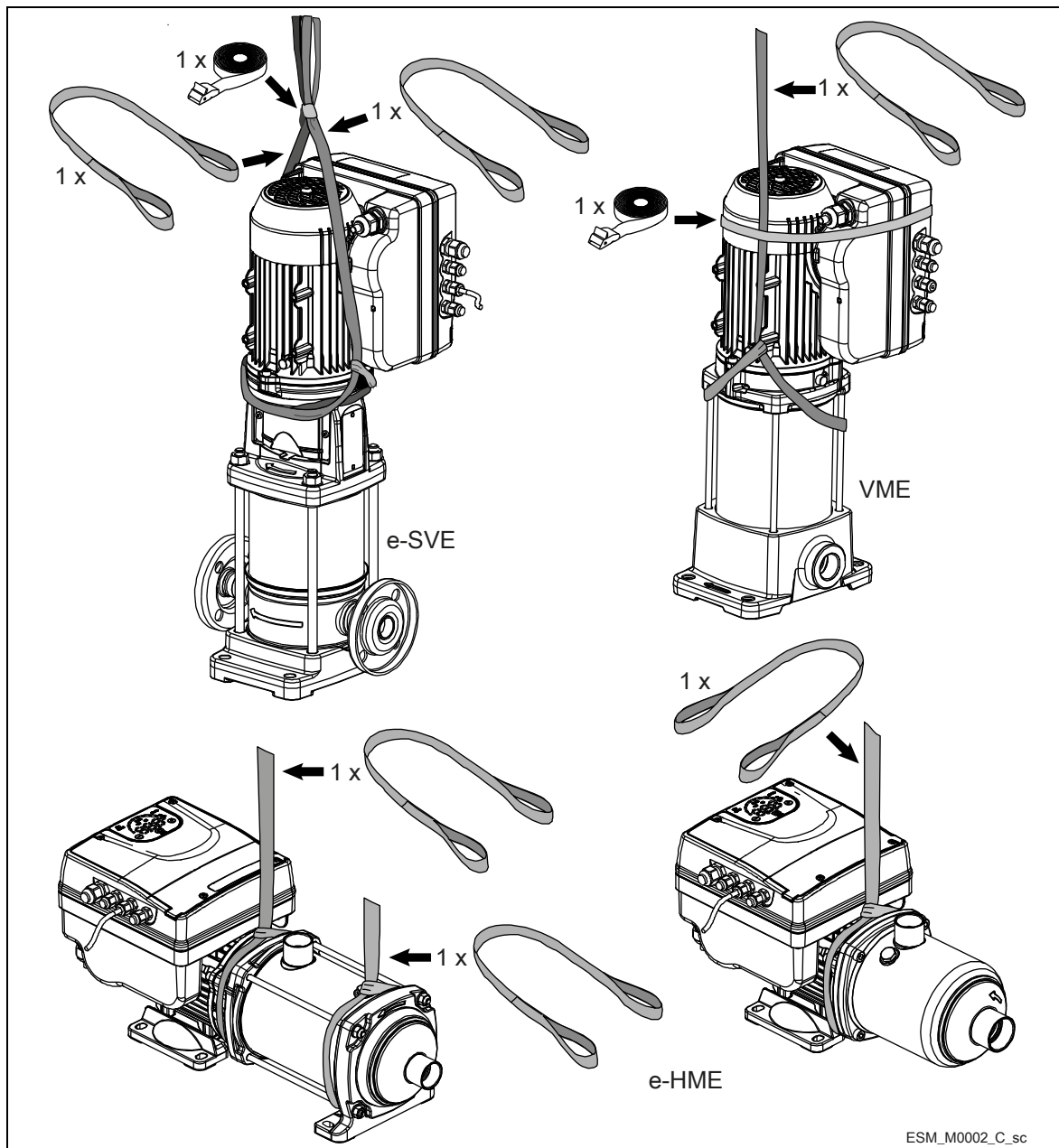

Figure 1: Lifting

2.2 Storage

The product must be stored:

- In a covered and dry place
- Away from heat sources
- Protected from dirt
- Protected from vibrations
- At an ambient temperature between -25°C and $+65^{\circ}\text{C}$ (-13°F and 149°F), and relative humidity between 5% and 95%.



NOTICE:

- Do not place heavy loads on top of the product
- Protect the product from collisions.



3 Technical Description

3.1 Designation

Variable speed pump unit, vertical/horizontal, multi-stage, non self-priming.

3.2 Data plates

The data plate is a label showing:

- The main product details
- The identification code

Approval and certifications

For the approvals see the motor data plate:

-
-

3.2.1 Motor

Motor data plate

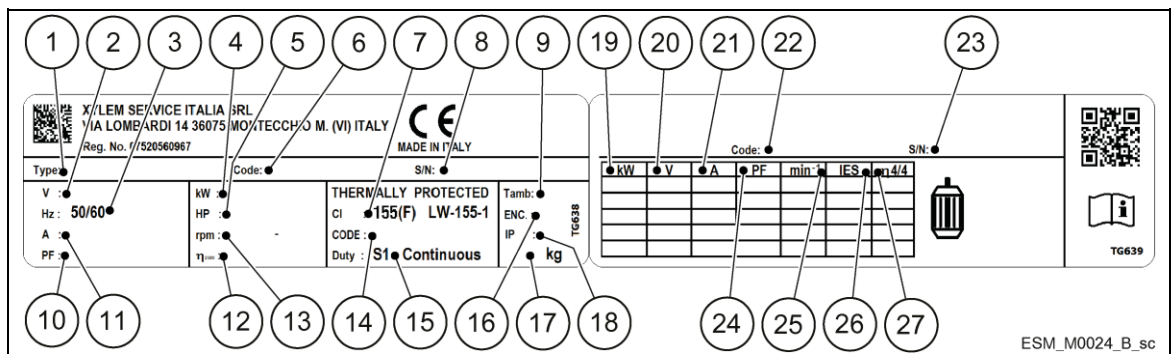

Figure 2: Motor data plate

- | | |
|----------------------------------|---|
| 1. Type definition code | 15. Duty type |
| 2. Rated voltage | 16. Enclosure type (NEMA) |
| 3. Rated frequency | 17. Weight |
| 4. Rated power [kW] | 18. Protection class |
| 5. Rated power [HP] | 19. Shaft power |
| 6. Part number | 20. Voltage |
| 7. Insulation class | 21. Current |
| 8. Serial number | 22. Part number |
| 9. Maximum ambient temperature | 23. Serial number |
| 10. Power factor | 24. Power factor |
| 11. Rated current | 25. Speed |
| 12. Motor drive efficiency | 26. Power drive system efficiency class (according to EN 50598-2) |
| 13. Full power speed range | 27. Full load efficiency |
| 14. Code letter for locked rotor | |

Motor type definition code

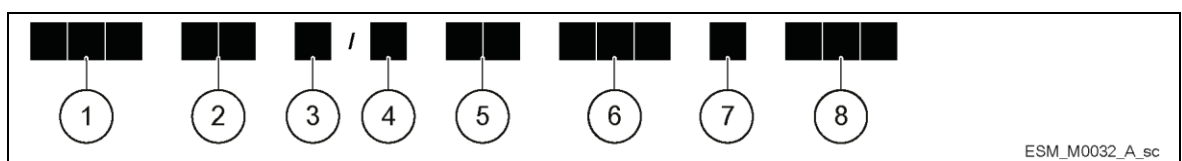

Figure 3: Motor type definition code

- 1. Series ESM
- 2. Motor frame dimension 90R: Oversized Flange
80: Standard Flange
- 3. Shaft extension □□: Standard shaft extension
S8: Custom Shaft extension
- 4. Power supply 1: single phase power supply
3: three phase power supply
- 5. Shaft power•10 [kW] 03: 0.37kW (0.50HP)
05: 0.55 kW (0.75 HP)
07: 0.75 kW (1.00 HP)
11: 1.10 kW (1.50 HP)
15: 1.50 kW (2.00 HP)
22: 2.20 kW (3.00 HP)
- 6. Motor frame arrangement SVE: Flange with tapped holes and shaft w/o keyseat
B14: Flange with tapped holes
B5: Flange with free holes
HMHA: Suitable for 1-5 e-HME monolithic pumps
HMHB: Suitable for 1-5 e-HME pumps w/sleeve
HMVB: Suitable for 1-5 VM pumps
HMHC: Suitable for 10-22 e-HME pumps
HMVC: Suitable for 10-22 VM pumps
LNEE: Suitable for In-Line pumps
56J: Compliant to NEMA 56 Jet standard
56C: Compliant to NEMA 56C standard
- 7. Reference market □□: Standard
EU: EMEA
US: North America
- 8. Voltage 208-240 : 208-240VAC 50/60Hz
380-460 : 380-460VAC 50/60Hz
230/400: 208-240/380-460VAC 50/60Hz

3.2.2 Pump

e-HME/VME data plate

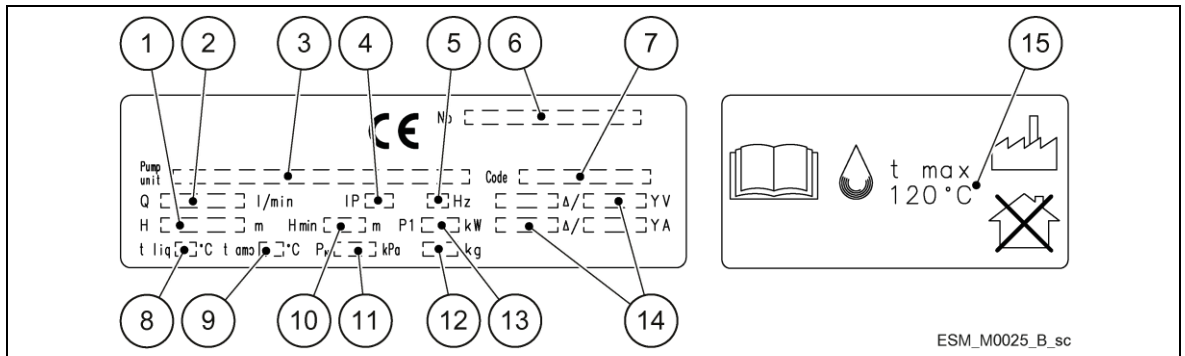

Figure 4: e-HME/VME data plate

- 1. Head range
- 2. Flow range
- 3. Pump/electric pump unit type definition code
- 4. Protection class
- 5. Frequency
- 6. Serial number (date+progressive number)
- 7. Electric pump unit/pump part number
- 8. Maximum operating liquid temperature (uses as EN 60335-2-41)
- 9. Maximum operating ambient temperature
- 10. Minimum head (EN 60335-2-41)
- 11. Maximum operating pressure
- 12. Electric pump unit weight
- 13. Electric pump unit absorbed power
- 14. Electrical data
- 15. Maximum operating liquid temperature (uses other than as EN 60335-2-41)

e-HME type definition code

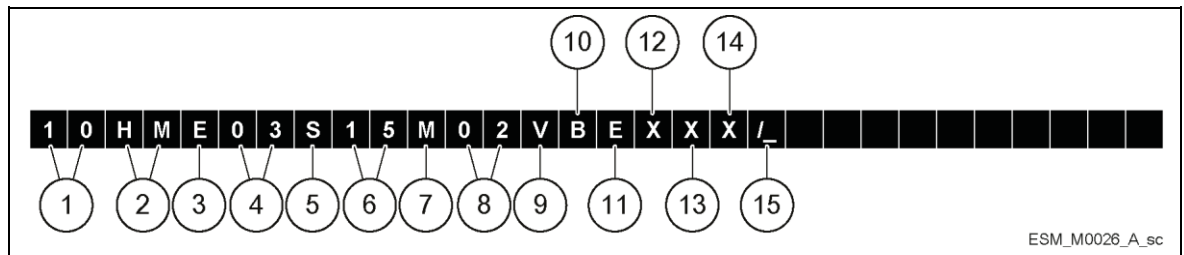

Figure 5: e-HME type definition code

- | | |
|-----------------------------|---|
| 1. Rated flow rate | [10] = m ³ /h |
| 2. Series name | [HM] |
| 3. Motor operation | [E] = e-SM |
| 4. Number of impeller | [03] = 3 impellers |
| 5. Material pump | [S] = Stainless steel (AISI 304) |
| 6. Motor power | kW x 10 |
| 7. Phase | [M] = Single-phase
[T] = Three-phase |
| 8. Power Supply Voltage | e-SM Power supply
02 = 1x208-240 V
04 = 3x380-460 V
05 = 3x208-240/380-460 V |
| 9. Rotating part | [Q] = Silicon Carbide (Q ₁)
[V] = Aluminium oxide (Ceramic) |
| 10. Stationary part | [Q] = Silicon Carbide (Q ₁)
[B] = Carbon resin impregnated |
| 11. Elastomers | [E] = EPDM
[V] = FPM
[K] = FFPM (Kairez®) |
| 12. General characteristics | Null = None
Z = other |
| 13. General characteristics | Null = None |
| 14. Connections | Null = Threaded |
| 15. | Null or letter assigned by the manufacturer |

VME type definition code

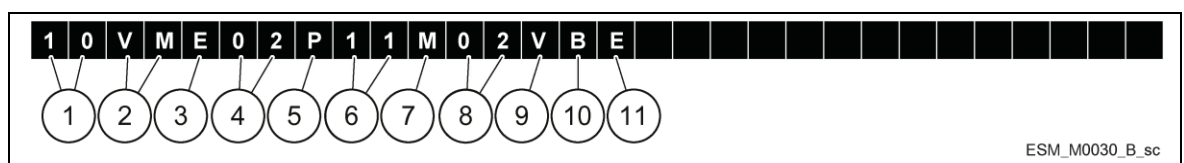

Figure 6: VME type definition code

- | | |
|-------------------------|---|
| 1. Rated flow rate | [10] = m ³ /h |
| 2. Series name | [VM] |
| 3. Motor operation | [E] = e-SM |
| 4. Number of impeller | [02] = 2 impellers |
| 5. Material pump | [P] = Stainless steel AISI 304 with Noryl™ impellers |
| 6. Motor power | kW x 10 |
| 7. Phase | [M] = Single-phase electric pump
[T] = Three-phase electric pump |
| 8. Power Supply Voltage | [2] = 1x208-240 V
[4] = 3x380-460 V
[5] = 3x208-240/380-460 V |
| 9. Rotating part | [V] = Aluminium oxide (Ceramic) |
| 10. Stationary parts | Carbon resin impregnated |
| 11. Elastomers | [E] = EPDM |

e-SVE data plate

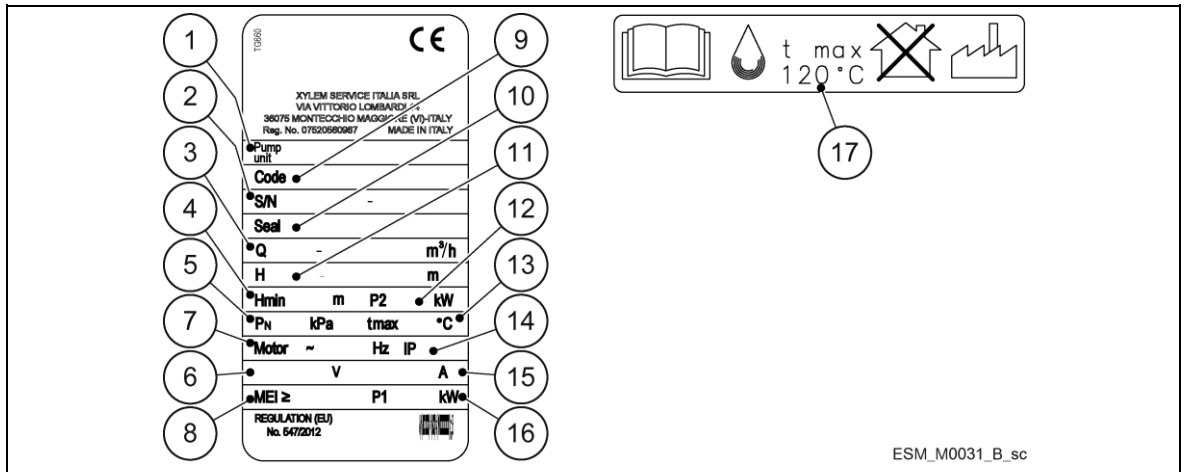

Figure 7: e-SVE data plate

- | | |
|--|---|
| 1. Pump/electric pump unit type | 10. Mechanical seal material identification code |
| 2. Serial number (date+progressive number) | 11. Head range |
| 3. Flow range | 12. Motor power |
| 4. Minimum head (EN 60335-2-41) | 13. Maximum operating liquid temperature (uses as EN 60335-2-41) |
| 5. Maximum operating pressure | 14. Protection class |
| 6. Rated voltage range | 15. Current |
| 7. Frequency | 16. Electropump unit absorbed power |
| 8. Minimum efficiency index | 17. Maximum operating liquid temperature (uses other than as EN 60335-2-41) |
| 9. Electric pump unit/ pump part number | |

e-SVE type definition code

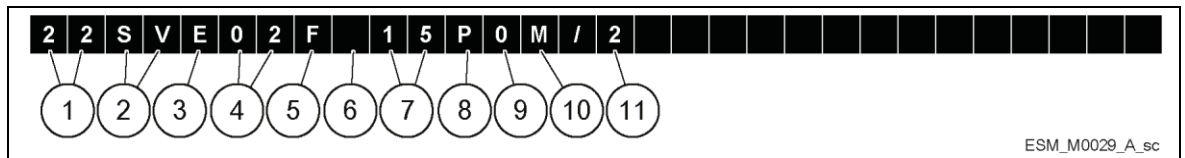

Figure 8: e-SVE type definition code

- | | |
|--------------------------|---|
| 1. Rated flow rate | [22] = m ³ /h |
| 2. Series name | [SV] |
| 3. Motor operation | [E] = e-SM |
| 4. Number of impeller | [02] = 2 impellers |
| 5. Material pump | [F] = Stainless steel AISI 304, round flanges (PN 25)
[T] = Stainless steel AISI 304, oval flanges (PN 16)
[R] = Stainless steel AISI 304, discharge port above suction, round flanges (PN 25)
[N] = Stainless steel AISI 316, round flanges (PN 25) |
| 6. Version | Null = standard version |
| 7. Motor power | kW x 10 |
| 8. Number of poles | [P] = e-SM |
| 9. Frequency | [0] = e-SM |
| 10. Phase | Null = pump
[M] = Single-phase electric pump
[T] = Three-phase electric pump |
| 11. Power Supply Voltage | [2] = 1x208-240 V
[4] = 3x380-460 V
[5] = 3x208-240/380-460 V |

3.3 Design and layout

The unit can be fitted with the features the application requires

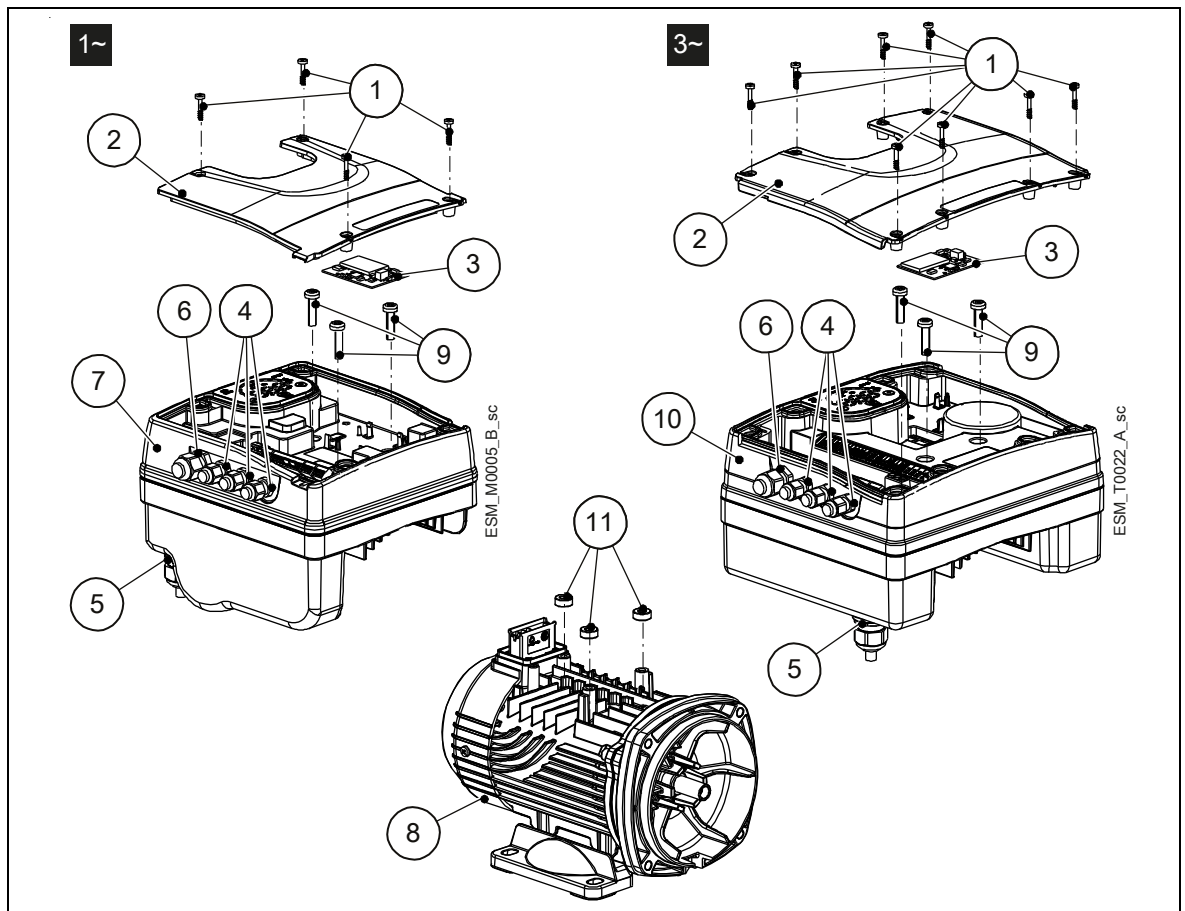

Figure 9: Main components - Single-phase and three-phase models

Table 1: Description of components

Position number	Description	Tightening torque $\pm 15\%$	
		[Nm]	[in•lbs]
1	Screw	1.4	12.4
2	Terminal Box Cover	-	-
3	Optional module with strip	-	-
4	M12 I/O cable gland	2.0	17.7
5	M20 cable gland for power supply cables	2.7	23.9
6	M16 I/O cable gland	2.8	24.8
7	Drive (single-phase model)	-	-
8	Motor	-	-
9	Screw	6.0	53.1
10	Drive (three-phase model)	-	-
11	Spacer	-	-

Pre-assembled ex factory components

Table 2: Included components

Component		Quantity	Notes
Plug for Cable Gland	M12	3	
	M16	1	
	M20	1	
Cable gland and lock nut	M12	3	Cable Outer Diameter: 3.7 to 7.0 mm (0.145-0.275 in)
	M16	1	
Cable Gland	M20	1	7.0 to 13.0 mm (0.275-0.512 in)

Optional components

Table 3: Optional components

Component	Description
Sensors	The following sensors can be used with the unit: <ul style="list-style-type: none"> Level-sensor
RS485 Module	For the connection of a multi-pump system to a supervision system, via cable (Modbus or BACnet MS/TP protocol)
Wireless Module	To connect and interact wireless with e-SM Drive
Adaptor	M20 Metric to 1/2" NPT Adapter (item is always supplied for US market)

3.4 Intended use

The product can be used to pump:

- Cold water
- Hot water

Refer to the standard Installation, Operation and Maintenance Manual for pump design specification.

The variable speed pump units are made for the following applications:

- Pressure, level, and flow regulation (open loop systems)
- Single or multi pump irrigation systems.

3.4.1 Application alternatives

Actuator (constant speed)

The unit operates as an actuator according to speed set point; this is done through user interface, the corresponding analog input or the communication bus.

Controller (constant pressure)

This mode is set as the default operating mode, and is used for single pump operating units.

Cascade serial / Cascade synchronous

The units are connected via the RS485 interface and communicate via the provided protocol. The combination of the different units which are used in a multi-pump system depends on the system requirements.

It is possible to run all pumps in cascade serial mode and cascade synchronous mode as well. If one unit fails, then each pump of the system can become the lead pump and can take control.

3.5 Improper use

The product must not be used for closed loop systems.



4 Installation

4.1 Mechanical installation

4.1.1 Installation area



DANGER: Potentially explosive atmosphere hazard

The operation of the unit in environments with potentially explosive atmospheres or with combustible dusts (e.g.: wood dust, flour, sugars and grains) is strictly forbidden.



WARNING:

- Always wear personal protective equipment
 - Always use suitable working tools
 - When selecting the place of installation and connecting the unit to the hydraulic and electric power supplies, strictly comply with current regulations.
 - Ensure that the input protection rating of the unit (IP 55, NEMA Type 1) is suitable for the installation environment.
-



CAUTION:

- Input protection: to ensure the IP55 (NEMA type 1) protection index make sure that the unit is closed correctly.
 - Before opening the terminal box cover, make sure that there is no water in the unit
 - Make sure that all unused cable glands and cable holes are correctly sealed
 - Make sure that the plastic cover is correctly closed
 - Do not leave the terminal box without cover: risk of damage due to contamination.
-

4.1.2 Unit installation

- See the Quick Startup Guide instructions (code 001080128)
- Position the unit as shown in Figure 10
- Install the unit according to the systems liquid flow.
- The arrows on the pump body indicate the flow and the rotation direction
- The standard rotation direction is clockwise (looking at the fan cover)
- Always install a backflow-prevention device on the suction side.
- Always install the pressure sensor on the delivery side, after the check valve.

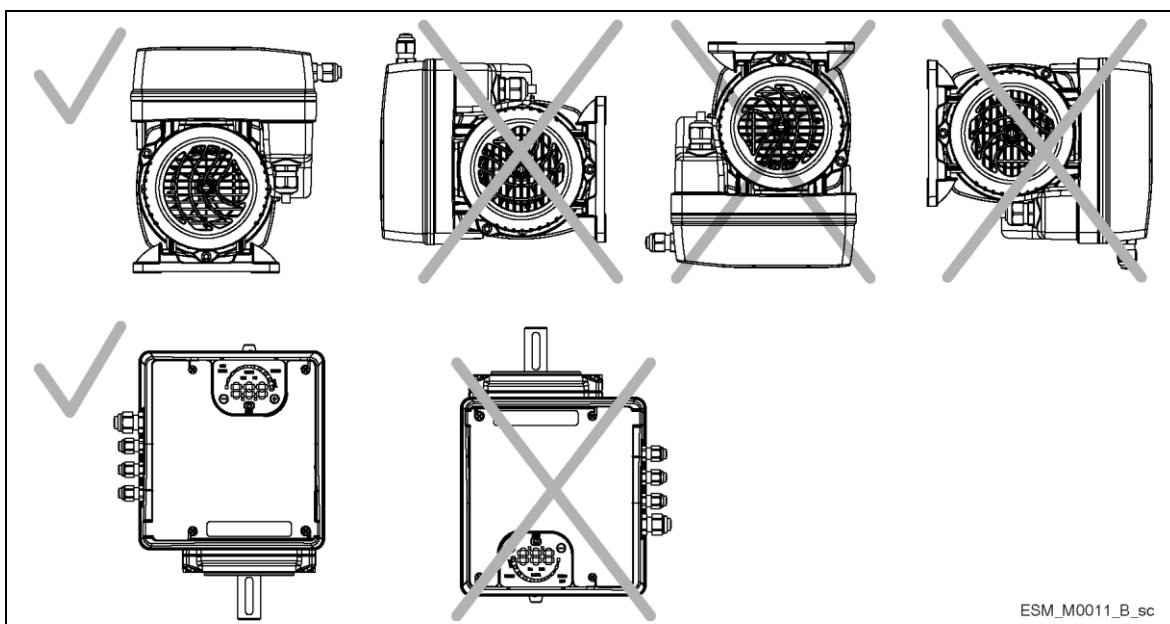

Figure 10: Permitted positions

4.1.3 Outdoor unit installation

In case of outdoor unit installation, ensure appropriate cover (see example in Figure 11). The size of the cover must be such that the motor is not exposed to snow, rain or direct sunlight; comply with the guidelines of Par. 9, Table 16.

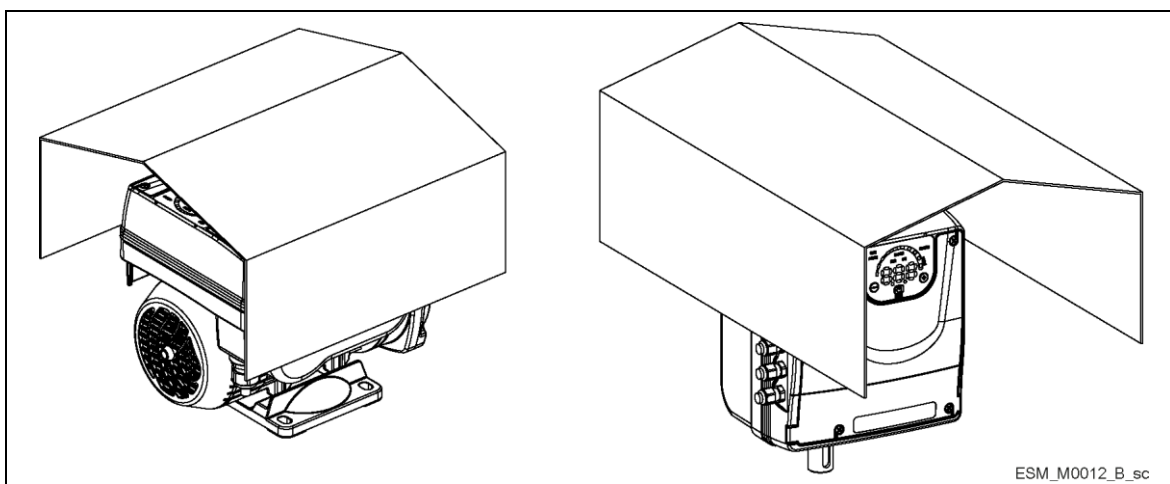

Figure 11: Outdoor installation

Minimum spacing

Area	e-SM Drive model	Free Distance
Above the unit	103..105..107..111..115	> 260mm (10.2 in)
Center-distance between units (to ensure space for cabling)	103..105..107..111..115	> 260mm (10.2 in)
	303..305..307..311..315..322	≥ 300mm (11.8 in)

4.2 Hydraulic installation

Figure 12 and 13 show a single pump system and a multi-pump system respectively.

NOTICE:

If the system is directly connected to the water network, install a minimum pressure switch on the suction side.

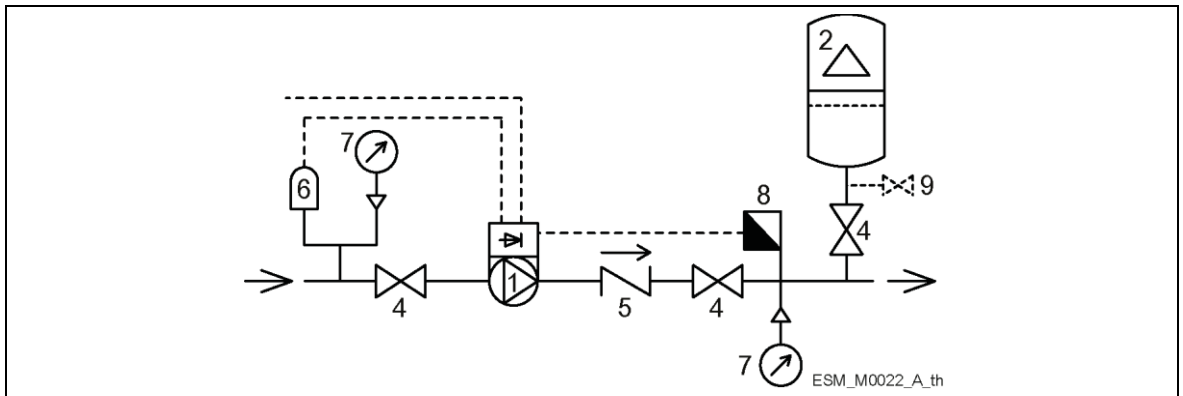

Figure 12: Single-pump system

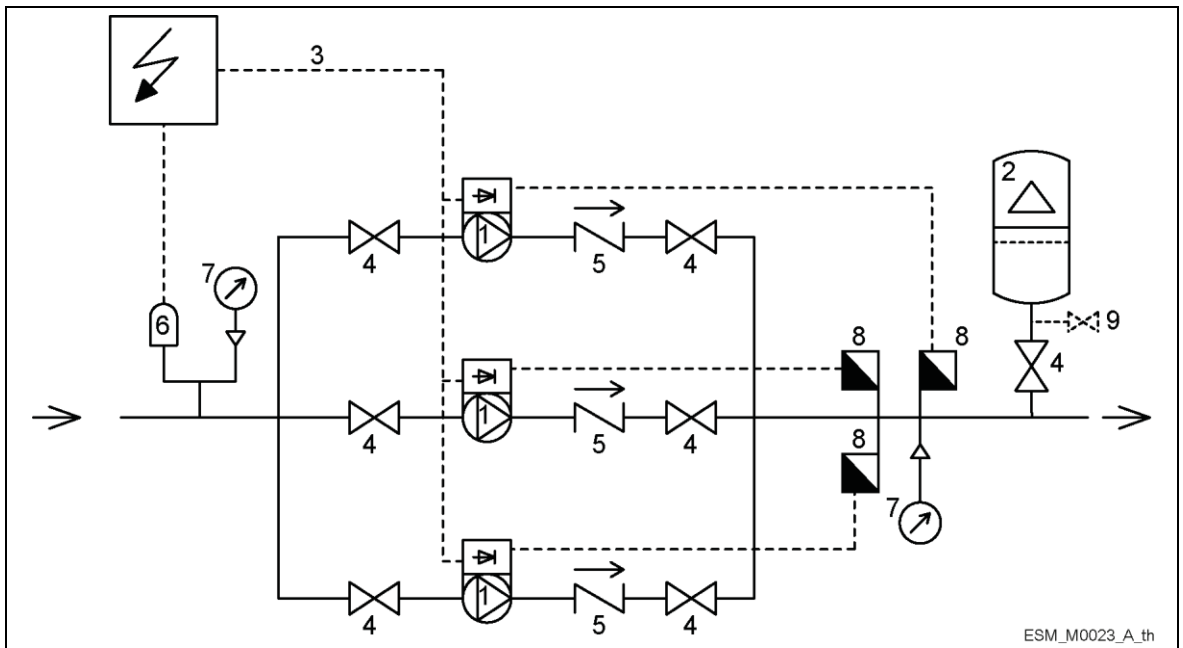

Figure 13: Multi-pump system

- | | | |
|-------------------------------|----------------------|--------------------|
| 1. Pump with e-SM Motor Drive | 4. On-off valve | 7. Pressure gauge |
| 2. Diaphragm pressure tank | 5. Non-return valve | 8. Pressure sensor |
| 3. Distribution panel | 6. Low water control | 9. Drain tap |

Pressure tank

On the pump delivery side there is a membrane expansion vessel, which gives the possibility of maintaining the pressure inside the piping when the system is not being used. The unit stops the pump from continuing to run at zero demand and reduce the size of the tank that is required for supply purposes.

Select a vessel suitable for the system pressure, and pre-load it in accordance with the values indicated in the Quick Startup Guide (code 001080128).

4.3 Electrical Installation



DANGER: Electrical hazard

The connection to the electric power supply must be completed by an electrician possessing the technical-professional requirements outlined in the current regulations.

4.3.1 Electrical requirements

Local directives prevail on the specific requirements indicated below.

Electrical connection checklist

Check that the following requirements are met:

- The electrical leads are protected from high temperature, vibrations, and collisions.
- The current type and voltage of mains connection must correspond to the specifications on the data plate on the pump.
- The power supply line is provided with:
 - A high-sensitivity differential switch (30 mA) [residual current device RCD] suitable for earth fault currents with DC or pulsating DC content (a Type B RCD is suggested).
 - A mains isolator switch with a contact gap of at least 3 mm.

The electrical control panel checklist

NOTICE:

The control panel must match the ratings of the electric pump. Inappropriate combinations do not guarantee the protection of the unit.

Check that the following requirements are met:

- The control panel must protect the pump against short-circuit. A time lag fuse or a circuit breaker (Type C model is suggested) can be used to protect the pump.
- The pump has built in overload and thermal protection, no additional overload protection is required.



DANGER: Electrical hazard

Before starting work on the unit, make sure that the unit and the control panel are isolated from the power supply and cannot be energized.

Grounding (earthing)



DANGER: Electrical hazard

- Always connect the external protection conductor to the ground terminal before attempting to make any other electrical connections
 - Connect all the electric accessories of the pump and the motor to the ground, making sure that the connections are completed correctly
 - Check that the protection conductor (ground) is longer than the phase conductors; in case of accidental disconnection of the power supply conductor, the protection conductor (ground) must be the last one to detach itself from the terminal.
-

Use a cable with several strands to reduce electric noise.

4.3.2 Wire types and ratings

- All cables must comply with local and national standards in terms of section and ambient temperature
- Use cables with minimum heat resistance +70°C (158°F); to ensure compliance with UL (Underwriters Laboratories) regulations, all power supply connections must be completed using the following types of copper cables with minimum resistance +75°C: THW, THWN
- Cables must never enter into contact with the motor body, the pump and the piping.
- The wires connected to the power supply terminals and the fault signal relay (NO, C) must be separated from the others by means of reinforced insulation.

Table 4: Electric connection cables

e-SM Drive models	Power supply input cable + PE		Tightening torque	
	Wire numbers x Max. copper section	Wire numbers x Max. AWG	Mains and motor cable terminals	Earth Conductor
103, 105, 107, 111, 115	3 x 1.5 mm ² 3 x 0.0023 sq.in	3 x 15 AWG	Spring connectors	Spring connectors
303, 305, 307, 311, 315, 322	4 x 1.5 mm ² 4 x 0.0023 sq.in	4 x 15 AWG	0.8 Nm 7.1 lb-in	3 Nm 26.6 lb-in

Control cables

External volt free contacts must be suitable for switching < 10 VDC.

NOTICE:

- Install the control cables separate from the power supply cables and the fault signal relay cable
- If the control cables are installed in parallel with the power supply cable or the fault signal relay, the distance between the cables must exceed 200 mm
- Do not intersect the power supply cables; should this be necessary, a 90° intersection angle is permitted.

Table 5: Recommended control cables

e-SM Drive control cables	Wires number x Max. copper Section	AWG	Tightening torque
All I/O conductors	0.75-1.5 mm ² 0.00012-0.0023 sq.in	18-16 AWG	0.6 Nm 5.4 lb-in

4.3.3 Power supply connection



WARNING: Electrical hazard

Contact with electric components may cause death, even after the unit has been switched off. Before any interventions on the unit, the network voltage and any other input voltages must be disconnected for the minimum time indicated in Table 9.

Table 6: Power supply wiring procedure

	Reference
1. Open the terminal box cover (2) by removing the screws (1).	Fig. 9
2. Insert the power cable in the M20 cable gland (5)	
3. Connect the cable according to the wiring diagram.	
4. Connect the earth conductor (mass), making sure that it is longer than the phase conductors.	Fig. 14
5. Connect the phase leads.	
6. Close the cover (2) and tighten the screws (1).	Fig. 9

Table 7: I/O wiring procedure

	Reference
1. Open the terminal box cover (2) by removing the screws (1).	Fig. 9
2. Connect the cable according to the wiring diagram.	Fig. 15
3. Close the cover (2) and tighten the screws (1).	Fig. 9

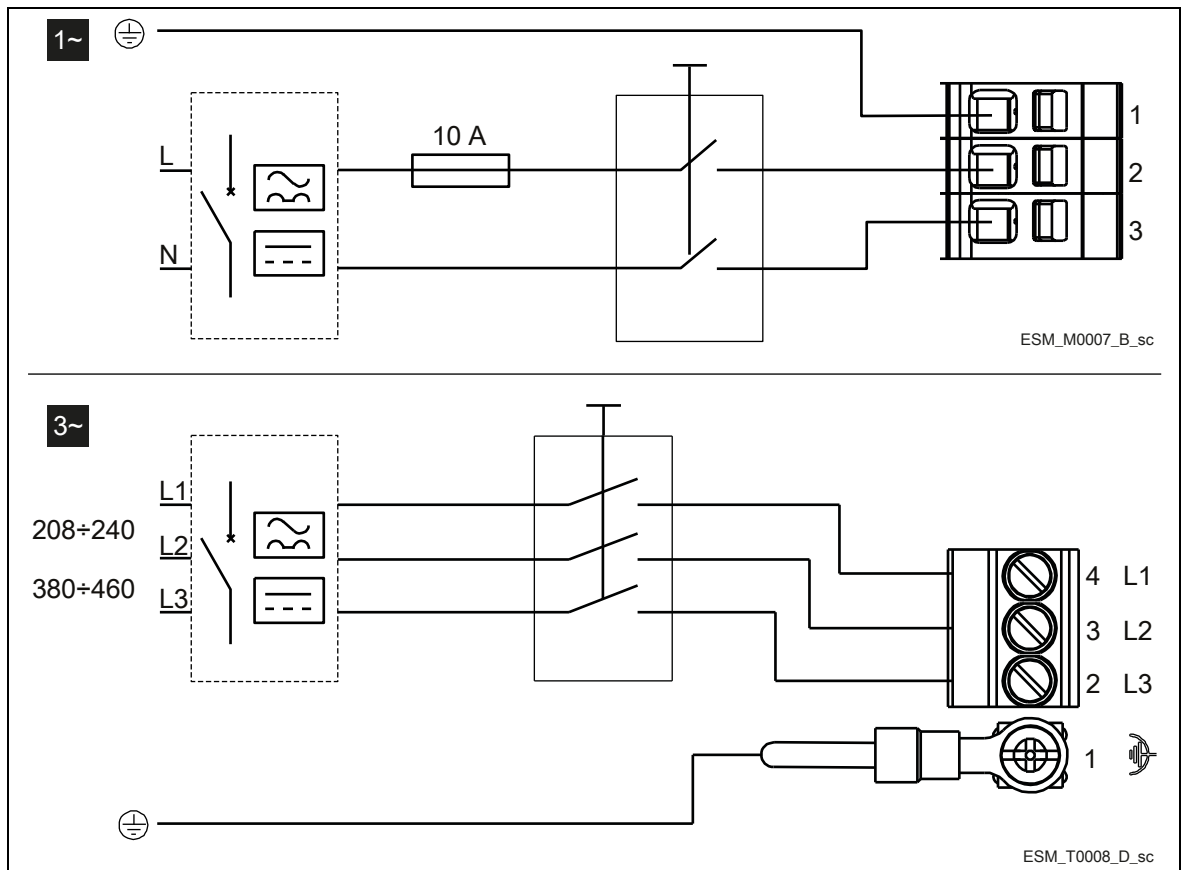

Figure 14: Wiring diagram

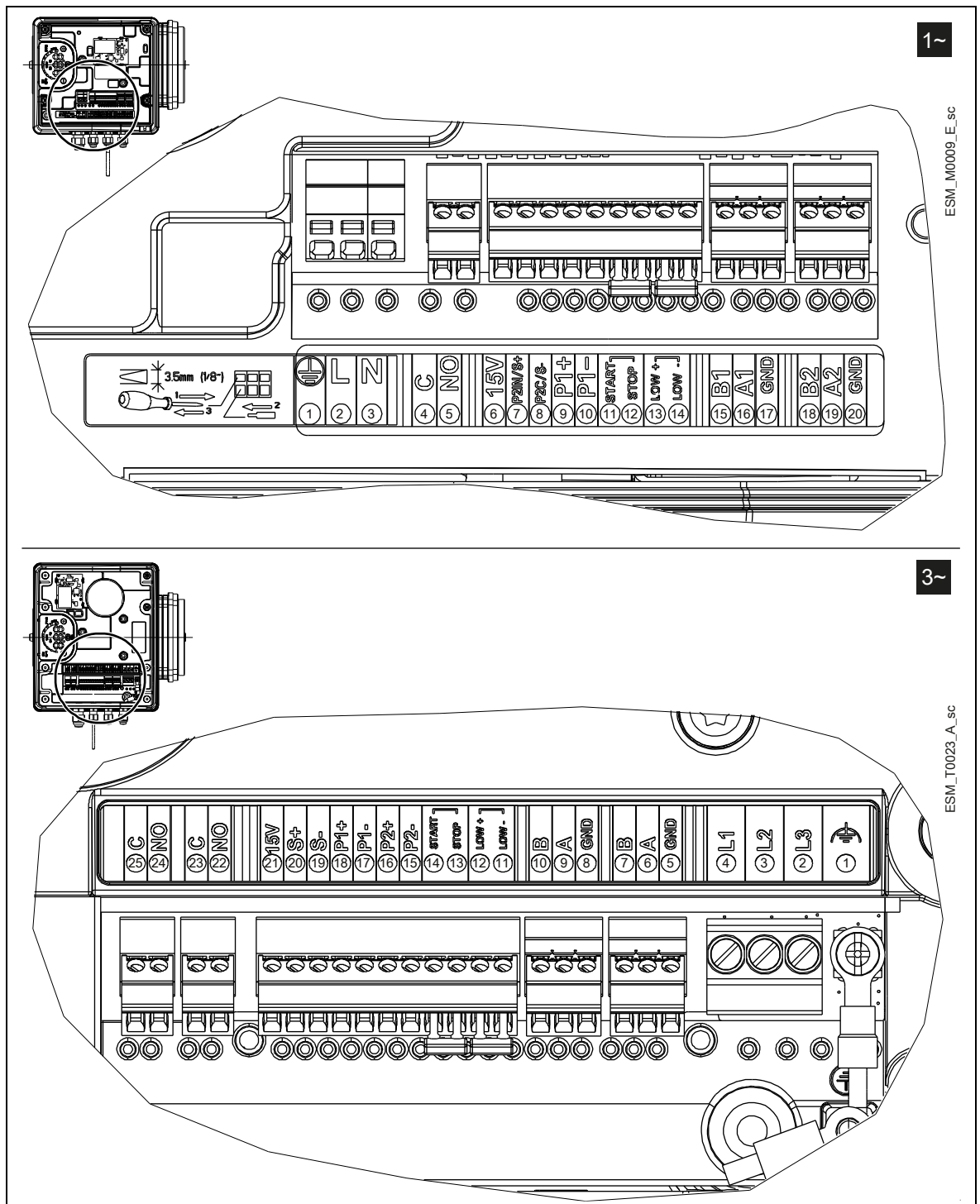

Figure 15: Connection label

Table 8: I/O terminals

	Item	Terminals	Ref.	Description	Notes
1~	Fault Signal	C	4	COM - error status relay	
		NO	5	NO - error status relay	
	Auxiliary Voltage Supply	15V	6	Auxiliary voltage supply +15 VDC	15VDC, Σ max. 100 mA
	Analog input 0-10V	P2IN/S+	7	Actuator mode 0-10 V input	0-10 VDC
		P2C/S-	8	GND for 0-10 V input	GND, electronic ground (for S+)
External Pressure	P1+	9	Power supply external sensor +15	15VDC, Σ max. 100 mA	

	sensor [also Differential]			VDC	
		P1-	10	External sensor 4-20 mA input	4-20 mA
	External Start/Stop	START	11	External ON/OFF input reference	Default short circuited Pump is enabled to RUN
		STOP	12	External ON/OFF input	
	External Lack of Water	LOW+	13	Low water input	Default short circuited Lack of water detection: enabled
		LOW-	14	Low water reference	
	Communication bus	B1	15	RS485 port 1: RS485-1N B (-)	ACT, HCS control mode: RS 485 port1 for external communication MSE, MSY control mode: RS 485 port 1 for multi-pump systems
		A1	16	RS485 port 1: RS485-1P A (+)	
		GND	17	Electronic GND	
	Communication bus	B2	18	RS485 port 2: RS485 port 2: RS485-2N B (-) active only with optional module	RS 485 port2 for external communication
		A2	19	RS485 port 2: RS485 port 2: RS485-2P A (+) active only with optional module	
		GND	20	Electronic GND	
3~	Fault signal	C	25	COM - error status relay	In case of power cables: use the M20 cable gland
		NO	24	NO - error status relay	
	Motor running signal	C	23	Common contact	In case of power cables: use the M20 cable gland
		NO	22	Normally open contact	
	Auxiliary Voltage Supply	15V	21	Auxiliary voltage supply +15 VDC	15VDC, Σ max. 100 mA
	Analog input 0-10V	S+	20	Actuator mode 0-10 V input	0-10 VDC
		S-	19	GND for 0-10 V input	GND, electronic ground (for S+)
	External Pressure sensor [also Differential]	P1+	18	Power supply external sensor +15 VDC	15VDC, Σ max. 100 mA
		P1-	17	External sensor 4-20 mA input	4-20 mA
	External pressure sensor	P2+	16	Power supply external sensor +15 VDC	15VDC, Σ max. 100 mA
		P2-	15	Sensor 4-20 mA input	4-20 mA
	External Start/Stop	Start	14	External ON/OFF input	Default short circuited Pump is enabled to RUN
		Stop	13	External ON/OFF input reference	
	External Lack of Water	LoW+	12	Low water input	Default short circuited Lack of water detection: enabled
		LoW-	11	Low water reference	
	Communication Bus	B2	10	RS485 port 2: RS485 port 2: RS485-2N B (-) active only with optional module	RS 485 port2 for external communication
		A2	9	RS485 port 2: RS485 port 2: RS485-2P A (+) active only with optional module	
		GND	8	Electronic GND	
Communication Bus	B1	7	RS485 port 1: RS485-1N B (-)	ACT, HCS control mode: RS 485 port 1 for external communication Control mode MSE, MSY: RS 485 port 1 for multi-pump systems	
	A1	6	RS485 port 1: RS485-1P A (+)		
	GND	5	Electronic GND		

5 Operation



In case of co-existence of two or more of the following conditions:

- high ambient temperature
 - high water temperature
 - duty points insisting on unit maximum power
 - persisting undervoltage of mains,
- may jeopardise the life of the unit, and/or derating may occur: for further information contact Xylem or the Authorised Distributor.

5.1 Wait times



WARNING: Electrical hazard

Contact with electric components may cause death, even after the unit has been switched off. Before any interventions on the unit, the network voltage and any other input voltages must be disconnected for the minimum time indicated in Table 9.

Table 9: Wait times

e-SM Drive model	Minimum waiting time (min)
103, 105, 107, 111, 115	4
303, 305, 307, 311, 315, 322	5



WARNING: Electrical hazard

Frequency converters contain DC-link capacitors that can remain charged even when the frequency converter is not powered.

To avoid electrical hazards:

- Disconnect the AC power supply
 - Disconnect all types of permanent magnet motors
 - Disconnect all DC-link remote power supplies, including the battery backups, the Uninterrupted Power Supply units and the DC-link connections to other frequency converters
 - Wait for the capacitors to discharge completely before carrying out any maintenance or repairs; see Table 9 for the waiting times
-



6 Programming

Precautions

NOTICE:

- Carefully read and follow the following instructions before starting the programming activities, to avoid wrong settings that may cause malfunctioning
- All modifications must be done by qualified technicians.

6.1 Control panel

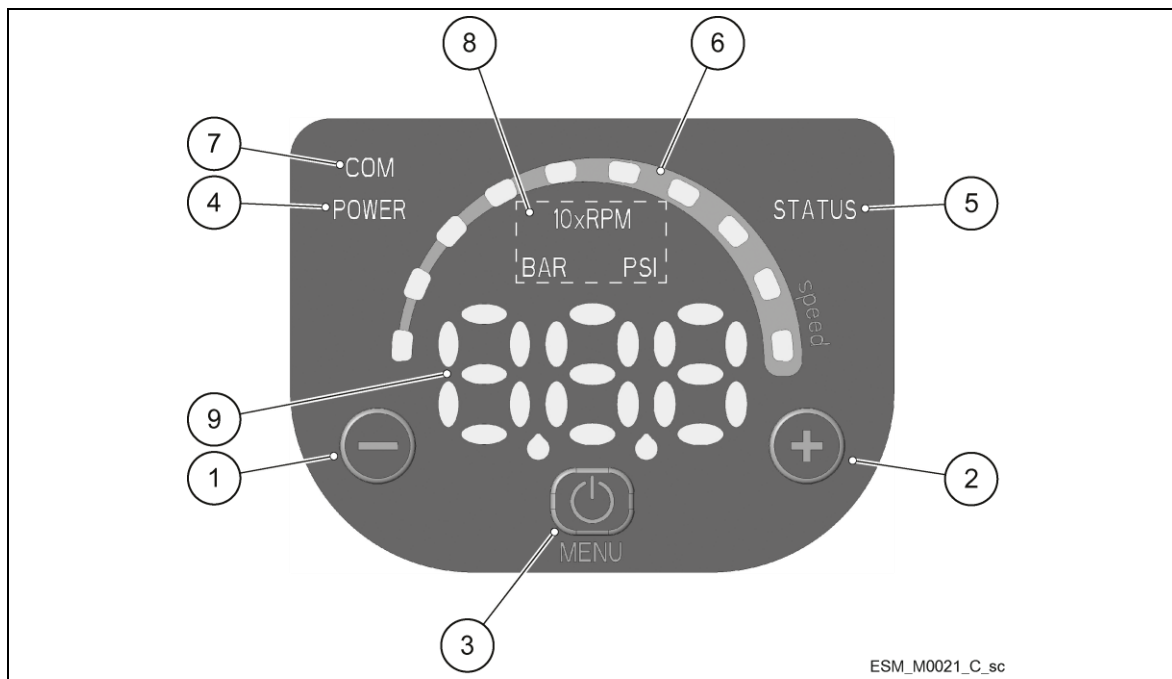









Figure 16: Control panel

Table 10: Description of the control panel

Position number	Description	Para.
1	Decrease button	6.2
2	Increase button	6.2
3	START/STOP and menu access button	6.2
4	POWER LED	6.3.1
5	Status LED	6.3.2
6	Speed LED bar	6.3.3
7	Communication LED	6.3.4
8	Unit of measure LEDs	6.3.5
9	Display	6.4

6.2 Description of the buttons

Table 11: Functions of push buttons

Push button	Function
	<ul style="list-style-type: none"> Main view (see Par. 6.4.1): decreases the required value for the selected control mode Parameter menu (see Par. 6.4.2): decreases the displayed parameter index Parameter view / editing (see Par. 6.4.2): decreases the value of the displayed parameter Zero pressure auto-calibration (see Par. 6.5, P44): automatic calibration of the pressure sensor.
	<ul style="list-style-type: none"> Main view (see Par. 6.4.1): increases the required value for the selected control mode Parameter menu (see Par. 6.4.2): increases the displayed parameter index Parameter view / editing (see Par. 6.4.2): increases the value of the displayed parameter Zero pressure auto-calibration (see Par. 6.5, P44): automatic calibration of the pressure sensor.
	<ul style="list-style-type: none"> Main view (see Par. 6.4.1): START/STOP the pump Parameter menu (see Par. 6.4.2): switches to parameter view / editing Parameter view / editing (see Par. 6.4.2): saves the value of the parameter.
 long press	<ul style="list-style-type: none"> Main view (see Par. 6.4.2): switches to parameter selection Parameters Menu: switches to Main Visualization
 and 	Main view: alternates between Speed and Head units of measure (see Par. 6.4.1).
 and 	Main view: alternates between Speed and Head units of measure (see Par. 6.4.1).

6.3 LEDs description

6.3.1 POWER (power supply)

When ON (**POWER**) the pump is powered and the electronic devices are operational.

6.3.2 STATUS

LED	Status
Off	Pump unit stopped
Green steady	Pump unit in operation
Flashing green and orange	Non-locking alarm with the pump unit in operation
Orange steady	Non-locking alarm with the pump unit stopped
Red steady	Locking error, the pump unit cannot be started

6.3.3 SPEED (speed bar)

It consists of 10 LEDs, each representing, in percentage steps between 10 and 100%, the speed range between parameter P27 (minimum speed) and parameter P26 (maximum speed).

LED bar	Status
On	Motor in operation; the speed corresponds to the percentage step represented by the LEDs ON in the bar (e.g.: 3 LEDs ON = speed 30%)
First LED flashing	Motor in operation; the speed is lower than the absolute minimum, P27
Off	Motor stopped

6.3.4 COM (communication)

Condition 1

- The communication bus protocol is the Modbus RTU protocol; the P50 parameter is set to the Modbus value
- No optional communication module is used.

LED	Status
Off	The unit cannot detect any valid Modbus messages on the terminals provided for the communication bus
Green steady	The unit has detected a communication bus on the provided terminals and has recognised the correct addressing
Green flashing	The unit has detected a communication bus on the provided terminals and has not been addressed correctly
From green steady to off	The unit has not detected a valid Modbus RTU message for at least 5 seconds
From green steady to flashing	The unit has not been addressed correctly for at least 5 seconds

Condition 2

- The communication bus protocol is the BACnet MS/TP protocol; the P50 parameter is set to the BACnet value
- No optional communication module is used.

LED	Status
Off	The unit has received no valid requests from other BACnet MS/TP devices for at least 5 seconds
On steady	The unit is exchanging information with another BACnet MS/TP device

Condition 3

- A multi-pump control mode is selected (e.g. MSE or MSY)
- No optional communication module is used.

LED	Status
Off	The unit has received no valid requests from other pumps through the multi-pump BUS for at least 5 seconds
On steady	The unit is exchanging information with another pump through the multi-pump BUS

Condition 4

The optional communication module is being used.













LED	Status
Off	RS485 or wireless connection faulty or missing
Flashing	The unit is exchanging information with the communication module

6.3.5 Unit of measurement

LED on	Measurement active	Notes
10xRPM	Impeller rotation speed	The display shows the speed in 10xRPM
BAR	Hydraulic head	The display shows the value of the head in bar
PSI		The display shows the value of the head in psi

6.4 Display

6.4.1 Main visualization

Display	Mode	Description
OFF	OFF	Contacts 11 and 12 (see Par. 5.4) are not short-circuited. Note: It has lower display priority than STOP mode.
STP	STOP	Pump stopped manually. If the pump is switched on after setting P04 = OFF (see Par. 6.5.1), it is stopped so that the motor is not in operation, and STP flashes (STP → STP). To manually stop the pump: <ul style="list-style-type: none"> • Example A. HCS, MES, MSY control modes with initial required value (head) of 4.20 bar and minimum value 0.5 bar: 4.20 BAR →  press → STP once. • Example B. ACT control mode with initial required value (speed) of 200 10xRPM and minimum value 80 10xRPM: 200 10xRPM →  press → STP once.
ON	ON	Pump on; the motor starts following the selected control mode. It appears for a few seconds when contacts 11 and 12 (see Par. 5.4) are short circuited and the pump is not in STOP mode. To manually set the pump to ON mode: <ul style="list-style-type: none"> • Example A. HCS, MES, MSY control modes that reach a required value (head) of 4.20 bar, starting with a minimum value of 0.5 bar after manual stop: STP →  press → ON → once after a few seconds... → 4.20 BAR. • Example B. ACT control mode that reaches a requested value (speed) of 200 10xRPM, starting with a minimum value of 80 10xRPM after manual stop: STP →  press → ON → once, and after a few seconds... → 200 10xRPM. With the pump in operation, it is possible to display the Actual Head and the Actual Speed: <ul style="list-style-type: none"> • Example A HCS, MES, MSY control modes with Actual Head 4.20 bar and corresponding Actual Speed of 352 10xRPM: 4.20 BAR →  +  → 352 10xRPM → after 10 seconds or  +  → 4.20 BAR. • Example B ACT control mode with Actual Speed 200 10xRPM and corresponding Actual Head of 2.37 bar: 200 10xRPM →  +  → 2.37 BAR → after 10 seconds or  +  → 200 10xRPM.

6.4.2 Parameters menu visualization



The parameter menu gives the possibility to:

- select all the parameters (see Par. 6.5)
- access Parameter View / Editing (see Par. 6.2).

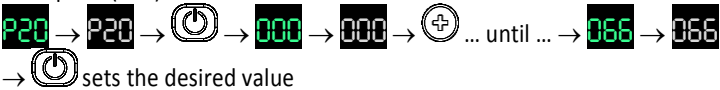
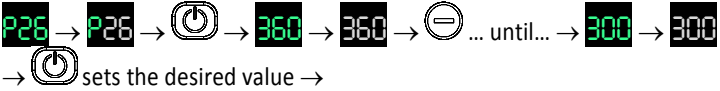
Parameter	Description
Power on	If after switching ON, parameter Menu View is accessed with P23 = ON, P20 flashes: P20 → P20 . Enter the password to display and change the parameters.

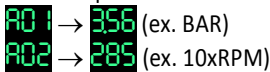

Password timeout	<p>If with P23 = ON no button is pressed for over 10 minutes from the last parameter Menu View, both the view and the editing of the parameters are disabled.</p> <p>Enter the password again to display and change the parameters.</p>
Parameters Menu	<p>With P23 = OFF, or after entering the password (P20), it is possible to both display and edit the parameters. When accessing the Parameter Menu, the display shows:</p> <p>P01 → P01 P02 → P02 ... P69 → P69</p> <p>The flashing parameter, indicating the selection possibility.</p>
Parameters Editing/Visualization	<p>The value of a parameter may be changed using the buttons, or the Modbus and BACnet communication protocols.</p> <p>When returning to the Parameter Menu, the displayed parameter index is increased automatically. For further information see Par. 6.5.</p> <ul style="list-style-type: none"> Example A (P20) from 000 to 066:  Example 2 (P26) from 360 to 300: 

6.4.3 Alarms and errors visualization









Parameter	Description
Alarm	<p>In case of alarm, the corresponding code appears on the display in alternation to the Main View.</p> <p>For example:  </p> <p>...</p>
Error	<p>In case of error, the corresponding identification code appears on the display.</p> <p>For example:  </p> <p>...</p>









6.5 Software parameters

Parameters are marked differently in the manual depending on their type:

Mark	Parameter type
No mark	Applicable to all units
	Global parameter, shared by all pumps in the same multi-pump system
	Read only

6.5.1 Status Parameters

No.	Parameter	Unit of measurement	Description
P01	Required value 	bar/psi/ rpmx10	This parameter shows the SOURCE and the VALUE of the active required value. Visualization cycles between SOURCE and VALUE occur every 3 seconds. SOURCES: <ul style="list-style-type: none"> SP (SP): internal required value Setpoint related to the control mode selected. VL (UL): external required value speed Setpoint related to 0-10V input. VALUE can represent a Speed or a Head, depending on the selected control mode: in case of Head, the unit of measure is defined by parameter P41.
P02	Effective Required Value 	bar/psi	Active required value calculated based on parameters P58 and P59. This parameter is effective only in control modes MSE or MSY. For further information on the calculation of P02, see Par. 6.6.3.
P03	Regulation Restart Value [0-100] 	%	It defines the start value after the stop of the pump, as a percentage of the P01 value. If the required value is met and there is no further consumption, then the pump stops. The pump starts again when the pressure drops below P03. P03 is valid when: <ul style="list-style-type: none"> Different from 100% (100%=off) The control mode is HCS, MSE or MSY. Default: 100%.
P04	Auto-start [OFF-ON] 		If P04 = ON, then the pump starts automatically following a power supply disconnection. If the pump is switched on after setting P04 = OFF (see Par. 6.5.1), it is stopped so that the motor is not in operation, and STP flashes (STP → STP). Default: ON.
P05	Operating time months 		Total months of connection to the electric mains, to add to P06.
P06	Operating time hours 	h	Total hours of connection to the electric mains, to add to P05.
P07	Motor Time Months 		This parameter shows the total operating time months, to be added to P08.
P08	Motor time hours 	h	This parameter shows the total operating time hours, to be added to P07.
P09	1st error 		This parameter stores the last error occurred in chronological order. The information displayed switches through the values: <ul style="list-style-type: none"> (Exx): xx indicates the error code (Hyy): yy is the value of hours referred to P05-P06 when the error Exx happened (Dww): ww is the value of days referred to P05-P06 when the error Exx happened (Uzz): zz is the value of weeks referred to P05-P06 when the error Exx happened Example of visualisation: E04 → H10 → D03 → U15

P10	2nd error 		Saves the penultimate error in chronological occurred. Other characteristics: like P09.
P11	3rd error 		Saves the third from the last error in chronological occurred. Other characteristics: like P09.
P12	4th error 		Saves the fourth from the last error in chronological occurred. Other characteristics: like P09.
P13	Power Module Temperature 	°C	Temperature of the power module.
P14	Inverter Current 	A	This parameter shows the actual current supplied by the frequency converter.
P15	Inverter Voltage 	V	This parameter shows the actual estimated input voltage of the frequency converter.
P16	Motor Speed 	rpmx10	This parameter shows the actual motor rotational speed.
P17	Software version 		This parameter shows the Control Board software version.

6.5.2 Settings Parameters

No.	Parameter	Description
P20	Password entering [0-999]	The user can enter here the system password, which gives access to all system parameters: this value is compared with the one stored in P22. When a correct password is entered, the system remains unlocked for 10 minutes.
P21	Jog mode [MIN-MAX*]	It deactivates the internal controller of the unit and forces the actual Control Mode (ACT): the motor starts and the value of P21 becomes the temporary ACT setpoint. It can be changed by just entering a new value on P21 without confirming it; otherwise, it causes immediate exit from temporary control.
P22	System password [1-999]	This is the system password, and must be the same as the password entered in P20. Default: 66.
P23	Lock Function [OFF, ON]	By using this function, the user can lock or unlock parameter setting in the main menu. When ON, enter the P20 password to change the parameters. Default: ON.

6.5.3 Drive Configuration Parameters

No.	Parameter	Unit of measurement	Description
P25	Control mode [ACT, HCS, MSE, MSY]		<p>This parameter sets the Control Mode (default value: HCS)</p> <p>ACT: Actuator mode. A single pump maintains a fixed speed at any flow rate. ACT will always try to minimize the difference between the speed setpoint and the actual rotational speed of the motor. If a 0-10V signal is supplied to terminals 7 and 8, the pump automatically switches to ACT mode, following the external signal, as shown in figure 17. If the external signal is missing, the pump remains in ACT mode, using the value set as setpoint using the display.</p> <p>HCS: Hydrovar® Controller mode for Single pump. The pump maintains a constant pressure at any flow rate: the Hydrovar® algorithm, based on the set of parameters from P26 to P37 (see Par. 6.5.3), is implemented. HCS mode must be set in conjunction with the use of an absolute reading pressure sensor installed in the hydraulic circuit, which</p>

* Depending on the type of pump used







			<p>supplies to the unit the pressure feedback signal: HCS will always try to minimize the difference between the pressure setpoint and the pressure feedback signal.</p> <p>MSE: Hydrovar® Controller mode for multiple pumps in Serial Cascade. Pumps are managed in series: only the last activated pump modulates the speed to maintain the set pressure, while all the others in operation rotate at the maximum speed. The set of pumps, connected to each other through the multi-pump protocol, maintains a constant pressure at any flow rate: the Hydrovar® algorithm, based on the set of parameters from P26 to P37 (see Par. 6.5.3), is implemented. MSE mode must be set in conjunction with the use of absolute reading pressure sensors, one for each pump, which supply to the set the pressure feedback signal: MSE will always try to minimize the difference between the pressure setpoint and the pressure feedback signal. Using the multi-pump protocol, it is possible to connect up to 3 pumps, all of the same type and with the same power.</p> <p>MSY: Hydrovar® Controller mode for Multiple pumps in Synchronous Cascade. The pumps are synchronised: they all keep the set pressure and operate at the same speed. Other characteristics: as for MSE mode.</p>
P26	Max RPM set [ACT set-Max*] G	rpmx10	Maximum pump speed setup.
P27	Min RPM set [Min*-ACT set] G	rpmx10	Minimum pump speed setup.
P28	Ramp 1 [1-250] G	s	This parameter adjusts the fast acceleration time. It affects the control of the pump for HCS, MSE and MSY control modes (also see Par. 6.6.2). Default: 3 s.
P29	Ramp 2 [1-250] G	s	This parameter adjusts the fast deceleration time. It affects the control of the pump for HCS, MSE and MSY control modes (also see Par. 6.6.2). Default: 3 s.
P30	Ramp 3 [1-999] G	s	This parameter adjusts the slow acceleration. It determines: <ul style="list-style-type: none"> • The Hydrovar® adjustment speed, in case of small flow rate variations • The constant outgoing pressure. The ramp depends on the system being controlled, and affects the control of the pump in HCS, MSE and MSY modes (also see Par. 6.6.2). Default: 35 s.
P31	Ramp 4 [1-999] G	s	Adjustment of the slow deceleration time (also see Par. 6.6.2). Other characteristics: as for Ramp 3.
P32	Ramp Speed Min Acceleration [2.0-25.0] G	s	This parameter sets the fast acceleration time. It represents the acceleration ramp used by the Hydrovar® controller until the minimum speed of the pump is reached (P27). It affects the control of the pump for HCS, MSE and MSY control modes (also see Par. 6.6.2). Default: 2.0 s.

* Depending on the type of pump used

P33	Ramp Speed Min Deceleration [2.0-25.0]	s	This parameter sets the fast deceleration time. It represents the deceleration ramp used by the Hydrovar® controller for stopping the pump once the minimum speed of the pump is reached (P27). It affects the control of the pump for HCS, MSE and MSY control modes (also see Par. 6.6.2). Default: 2.0 s.
P34	Speed Min Configuration [STP, SMI]		This parameter defines the operation of the Hydrovar® controller once the minimum speed of the pump is reached (P27): <ul style="list-style-type: none"> (STP): once the required pressure is reached and no further request is made, the pump speed decreases to the selected P27 value: Hydrovar® then keeps running for the selected time interval (P35), and then stops automatically. (SMI): once the required pressure is reached and no further request is made, the pump speed decreases to the selected P27 value: Hydrovar® continues running at the same speed. This parameter affects the control of the pump for HCS, MSE and MSY control modes. Default: STP
P35	Smin time [0-100]	s	This parameter sets the time delay before a shut-off below P27 occurs. It is only used by the Hydrovar® controller if P34 = STP. It affects the control of the pump for HCS, MSE and MSY control modes. Default: 0 s.
P36	Window [0-100]	%	This parameter sets the ramp control interval, as a percentage of the pressure setpoint. It is used to define the range of pressures, around the setpoint, in which the Hydrovar® controller uses slow acceleration and deceleration ramps instead of fast ones. It affects the control of the pump for HCS, MSE and MSY control modes (also see Par. 6.6.2). Default: 10%.
P37	Hysteresis [0-100]	%	This parameter sets the slow ramp hysteresis, as a percentage of P36. It helps define the pressure range, around the setpoint, in which Hydrovar® goes from slow acceleration ramp (P28) to slow deceleration ramp (P29). The parameter affects the control of the pump for HCS, MSE and MSY control modes (also see Par. 6.6.2). Default: 80%.
P38	Speed Lift [0-MAX*]	rpmx10	This parameter sets the speed limit after which the linear increase of the actual require value starts (P02), until the total increase (P39) at maximum speed (P26). Default: P27.
P39	Lift Amount [0-200]	%	This parameter sets the increase value of the actual required value (P02) at the maximum speed (P26), measured as a percentage of the required value (P01). It determines the increase of the required pressure set, useful to compensate for flow resistances at high flow rates. Default: 0.

* Depending on the type of pump used

6.5.4 Sensor Configuration Parameters





No.	Parameter	Unit of measurement	Description
P41	Pressure Sensor Unit Of Measure [BAR, PSI] 		This parameter sets the unit of measure (BAR , PSI) for the pressure sensor. It affect the head view LED parameter (see Par. 6.3.4). Default: bar.
P42	Full scale value for pressure Sensor 1 4-20mA [0.0-25.0BAR] / [0.0-363PSI] 	bar/psi	This parameter sets the Full Scale value of the 4-20mA pressure sensor connected to analog input 17 and 18. Default: depending on the type of pump.
P44	Zero Pressure Auto-Calibration	bar/psi	This parameter lets the user perform the initial auto-calibration of the pressure sensor. It is used to compensate for the offset signal of the sensor at zero pressure caused by the tolerance of the sensor itself. Procedure: 1. Access P44 when the hydraulic system is at 0 pressure (no water inside), or with the pressure sensor disconnected from the piping: the actual value of 0 pressure is displayed. 2. Start the auto-calibration by pressing  or  (see Par. 6.2). 3. At the end of the auto-calibration, the 0 (zero) pressure is displayed, or the “---” (---) message, if the sensor signal is out of the permitted tolerance.
P45	Pressure Minimum Threshold [0-42] 	bar/psi	Setting the minimum pressure threshold. If the system pressure falls below this threshold for the time set in P46, a low pressure error E14 is generated. Default: 0 bar.
P46	Pressure Minimum Threshold - Delay Time [1-100] 	s	Time delay setup. This parameter sets the time delay during which the unit remains idle with a system pressure below P45, before generating the low pressure error E14. Default: 2 s.
P47	Pressure Minimum Threshold – Automatic Error Reset [OFF, ON] 		Enabling/disabling of automatic unit attempts in case of low pressure error. Default: ON.
P48	Lack Of Water Switch Input [DIS, ALR, ERR]		This parameter enables/disables the management of the lack of input water (see Par. 4.3.3, terminals 13 and 14). It defines the behaviour of the unit when the lack of water input is enabled and the switch is open: <ul style="list-style-type: none"> DIS (DIS): the unit doesn't manage the information coming from the "lack of water" input ALR (ALr): the unit reads the "lack of water" Input (enabled) and reacts, at the opening of the switch, by displaying the corresponding alarm A06 on the display, and keeping the motor running ERR (Err): Err, the unit reads the Lack Of Water Input (enabled) and reacts, at the opening of the switch, by stopping the motor and generating the corresponding error E11. The error condition is removed when the switch closes again and the motor is started. Default: ERR.

6.5.5 RS485 Interface Parameters

No.	Parameter	Unit of measurement	Description
P50	Communication protocol [MOD, BAC]		This parameter selects the specific protocol on the communication port: <ul style="list-style-type: none"> • MOD (MOD): Modbus RTU • BAC (BAC): BACnet MS/TP. Default: MOD.
P51	Communication protocol - Address [1-247]/[0-127]		This parameter sets the desired address for the unit, when connected to an external device, depending on the protocol selected in P50: <ul style="list-style-type: none"> • MOD: any value in the 1-247 range • BAC: any value in the 0-127 range.
P52	Comm Protocol – BAUDRATE [4.8, 9.6, 14.4, 19.2, 38.4, 56.0, 57.6 KBPS]	kbps	This parameter sets the desired baud rate for the communication port. Default: 9.6 kbps.
P53	BACnet Device ID Offset [0-999]		This parameter sets the hundreds, tens and units of the BACnet Device ID. Default: 002. Device ID default: 84002.
P54	Comm Protocol – Configuration [801, 802, 8E1, 801]		This parameter sets the length of the data bits, the parity and the length of the STOP bits.

6.5.6 Multi-pump configuration parameters

All these parameters affect MSE and MSY control modes.

No.	Parameter	Unit of measurement	Description
P55	Multipump – Address [1-3]		This parameter sets the address of each pump based on the following criteria: <ul style="list-style-type: none"> • Each pump needs an individual pump address (1-3) • Each address may only be used once. Default: 1.
P56	Multipump – Max Units [1-3] 		This parameter sets the maximum number of pumps operating at the same time. Default: 3.
P57	Multipump – Switch Interval [0-250] 	h	Setpoint of the main pump forced switch interval. If the pump with priority 1 works in continuous mode until this time is reached, the switch between this pump and the next is forced. If on the other hand, the system stops completely due to the setpoint being reached, with the next start priority 1 will be assigned in a way to ensure an even distribution of the operating hours of all pumps. Default: 24 h.
P58	Multipump – Actual Value Increase [0.0-25.0BAR] / [0.0-363PSI] 	bar/psi	This parameter affects the calculation of P02, to improve the Multipump control as described in paragraph 6.6.3. Default: 0.35 bar.
P59	Multipump – Actual Value Decrease [0.0-25.0BAR] / [0.0-363PSI] 	bar/psi	This parameter affects the calculation of P02, to improve the multipump control as described in paragraph 6.6.3. Default: 0.15 bar.

P60	Multipump – Enable Speed [P27-P26]	rpmx10	This parameter sets the speed that a pump must reach before starting the next assist pump, after a system pressure drop below the difference between P02 and P59. Default: depending on the type of pump.
P61	Multipump Synchronous – Speed Limit [P27-P26]	rpmx10	This parameter sets the speed limit below which the first assist pump stops. Default: depending on the type of pump.
P62	Multipump Synchronous – Window [0-100]	rpmx10	This parameter sets the speed limit for the stop of the next assist pump. Default: 150 rpmx10.
P63	Multipump – Priority		This parameter shows the pump priority value within the multi-pump set. This parameter displays the following information: Pr1 (Pr1) .. Pr3 (Pr3) or Pr0 (Pr0) where: <ul style="list-style-type: none"> Pr1 .. PR3, indicate that the pump is communicating with others pumps and its priority order, is equal to the visualized number. Pr0 indicates that the pump does not detect the communication with other pumps and is considered alone in the multi-pump bus
P64	Multipump – Revision		This parameter shows the multi-pump protocol revision value used.

6.5.7 Test Run Configuration Parameters

Test Run is a function that starts the pump after the last stop, in order to prevent it from blocking.

No.	Parameter	Unit of measurement	Description
P65	Test Run – Time Start [0-100]	h	This parameter sets the time after which, once the pump has stopped for the last time, the Test Run will start. Default: 100 h.
P66	Test Run – Speed [Min-Max]	rpmx10	This parameter sets the pump rotational speed for the Test Run. The Min and Max speeds depend on the pump type. Default: 200 rpmx10.
P67	Test Run – Time Duration [0-180]	s	This parameter sets the duration of the Test Run. Default: 10 s.

6.5.8 Special Parameters

No.	Parameter	Unit of measurement	Description
P68	Default Values Reload [NO, YES]		If set to RES, after confirmation this parameter performs a factory reset that reloads the default parameter values.
P69	Avoid Frequent Parameters Saving [NO, YES]		This parameter limits the frequency with which the unit stores the required value P02 in the EEPROM memory, in order to extend its life. This could be particularly useful in applications with BMS control devices that require continuous variation of the value for fine tuning purposes. Default: NO.

6.6.2 Example: Ramp Settings

Graph

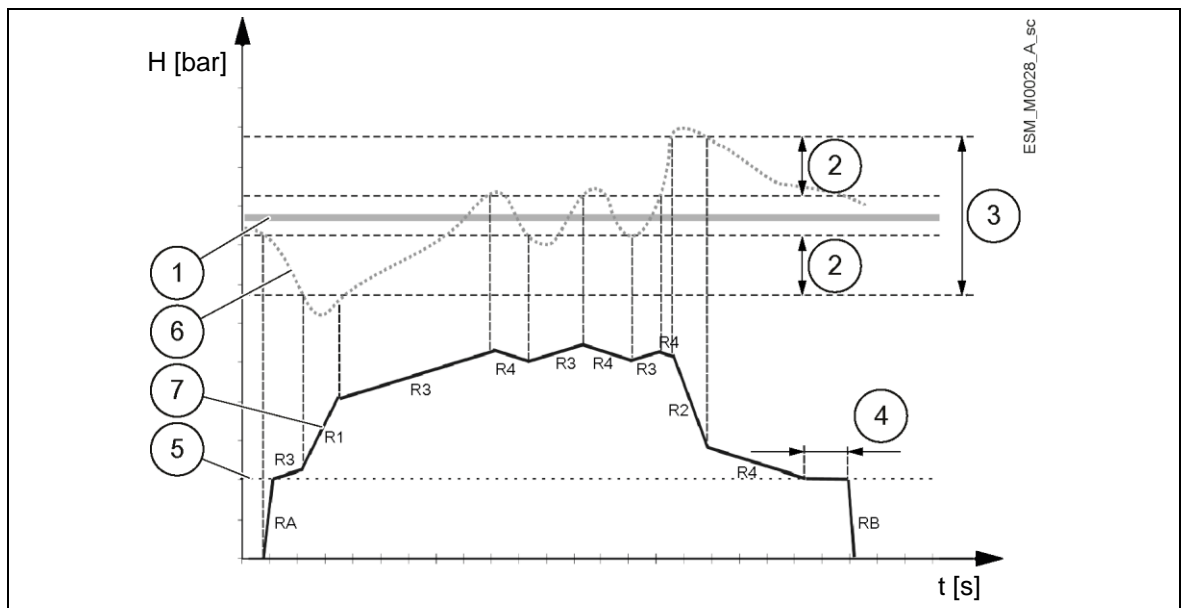

Figure 18: Ramp settings

Table 13: Description

1	P01 (Required Value)
2	P37 (Adjustment hysteresis) as a % of P36 (Adjustment window)
3	P36 (Adjustment window) as a % of P01 (Required Value)
4	P35 (Minimum speed - Duration)
5	P27 (Minimum speed)
6	→ Actual Head
7	→ Actual Speed
RA	→ P32 (Acceleration ramp at startup)
RB	→ P32 (Deceleration ramp at shutdown)
R1	→ P28 (Ramp 1) - Fast ramp speed increase
R2	→ P29 (Ramp 2) - Fast ramp speed decrease
R3	→ P30 (Ramp 3) - Slow ramp speed increase
R4	→ P31 (Ramp 4) - Slow ramp speed decrease

For further information on the adjustment of the ramps, see Par. 6.5.3.

6.6.3 Example: Effective Required Value

Pumps activation in cascade modes:

1. Lead pump reaches its P60 (Enable Speed).
2. Actual value falls to the cut in-value of the 1st assist pump.
The 1st assist pump switches on automatically. (Cut-in value = P01 (Required Value) - P59 (Actual Value Decrease))
3. A new required value, P02 (Effective Required Value) is calculated after the start up.

Calculation of Effective Required Value in Cascade Serial (MSE):

K = number of active pumps

Pr = pump priority

$P02 \text{ (Actual Required Value)} = P01 \text{ (Required Value)} + (K - 1) * P58 \text{ (Actual Value Increase)} - (Pr - 1) * P59 \text{ (Actual Value Decrease)}$

Calculation of Effective Required Value in Cascade Synchronous (MSY):

K = number of active pumps ($K \geq Pr$)

$P02 \text{ (Actual Required Value)} = P01 \text{ (Required Value)} + (K - 1) * (P58 - P59)$

Behaviour of P58 (Actual Value Increase) and P59 (Actual Value Decrease):

- if $P58 \text{ (Actual Value Increase)} = P59 \text{ (Actual Value Decrease)}$ → Pressure constant, independent of how many pumps are in operation.
- if $P58 \text{ (Actual Value Increase)} > P59 \text{ (Actual Value Decrease)}$ → Pressure rises when assist pump switches on.
- if $P58 \text{ (Actual Value Increase)} < P59 \text{ (Actual Value Decrease)}$ → Pressure decreases when assist pump switches on.

7 Maintenance



Precautions



DANGER: Electrical hazard

- Before attempting to use the unit, check that it is unplugged and that the pump and the control panel cannot restart, even unintentionally. This also applies to the auxiliary control circuit of the pump.
 - Before any interventions on the unit, the network power supply and any other input voltages must be disconnected for the minimum time indicated in Table 9 (the capacitors of the intermediate circuit must be discharged by the built-in discharge resistors).
-

1. Make sure that the cooling fan and the vents are free from dust.
2. Make sure that the ambient temperature is correct according to the limits of the unit.
3. Make sure that qualified personal perform all modifications of the unit.
4. Make sure that the unit is disconnected from the power supply before any work is carried out. Always consider the pump and motor Instruction.

Function and parameter control

In case of changes to the hydraulic system:

1. Make sure that all functions and parameters are correct
2. Adjust the functions and parameters if necessary.



8 Troubleshooting

In case of alarm or error, the display shows an ID code and the STATUS LED turns on (also see Par. 6.3.2).

In case of several alarms and/or errors, the display shows the main one.

Alarms and errors:

- are saved with date and time
- can be reset by switching the unit off for at least 1 minute.

Errors cause the triggering of the status relay on the following terminal box pins:

- single-phase version: pins 4 and 5
- three-phase version: pins 24 and 25

8.1 Alarm codes

Table 14: Alarm codes

code	Description	Cause	Remedy
A03	Derating	Temperature too high	<ul style="list-style-type: none"> • Lower the room temperature • Lower the water temperature • Lower the load
A05	Data memory alarm	Data memory corrupted	<ol style="list-style-type: none"> 1. Reset the default parameters using parameter P68 2. Wait 10 s 3. Restart the pump If the problem continues, contact Xylem or the Authorised Distributor
A06	LOW alarm	Lack of water detection (if P48= ALR)	Check the water level inside the tank
A15	EEPROM write failure	Data memory damaged	Stop the pump for 5 minutes and then restart it again; if the problem continues, contact Xylem or the Authorised Distributor
A20	Internal alarm		Stop the pump for 5 minutes and then restart it again; if the problem continues, contact Xylem or the Authorised Distributor
A30	Multi-pump connection alarm	Corrupted multi-pump connection	<ul style="list-style-type: none"> • Check the condition of the connection cables • Check that there are no address discrepancies
A31	Loss of multi-pump connection	Loss of multi-pump connection	Check the condition of the connection cables

8.2 Error codes

Table 15: Error codes

code	Description	Cause	Remedy
E01	Internal communication error	Internal communication lost	Stop the pump for 5 minutes and then restart it again; if the problem continues, contact Xylem or the Authorised Distributor
E02	Motor overload error	<ul style="list-style-type: none"> • High motor current • Current absorbed by the motor too high 	Stop the pump for 5 minutes and then restart it again; if the problem continues, contact Xylem or the Authorised Distributor

code	Description	Cause	Remedy
E03	DC-bus overvoltage error	<ul style="list-style-type: none"> DC-bus overvoltage External conditions cause the operation of the pump from generator 	Check: <ul style="list-style-type: none"> the system configuration the position and integrity of the non-return valves
E04	Rotor blocked	<ul style="list-style-type: none"> Motor stall Loss of rotor synchronism or rotor blocked by external materials 	<ul style="list-style-type: none"> Check that there are no foreign bodies preventing the pump from turning Stop the pump for 5 minutes and then start it again If the problem continues, contact Xylem or the Authorised Distributor
E05	EEPROM Data memory error	EEPROM Data memory corrupted	Stop the pump for 5 minutes and then restart it again; if the problem continues, contact Xylem or the Authorised Distributor
E06	Grid voltage error	Voltage supply out of operating range	Check: <ul style="list-style-type: none"> the voltage the connection of the electric system
E07	Motor winding temperature error	Motor thermal protection trip	<ul style="list-style-type: none"> Check for impurities near the impeller and rotor. Remove them if necessary Check the conditions of installation and the water and air temperature Wait for the motor to cool down If the error persists, stop the pump for 5 minutes and then start it again If the problem continues, contact Xylem or the Authorised Distributor
E08	Power module temperature error	Frequency converter thermal protection trip	Check the conditions of installation, and the air temperature
E09	Generic hardware error	Hardware error	Stop the pump for 5 minutes and then restart it again; if the problem continues, contact Xylem or the Authorised Distributor
E11	LOW error	Lack of water detection (if P48=ERR)	Check the water level inside the tank
E12	Pressure sensor error	Missing pressure sensor (not present in ACT mode)	Check the condition of the sensor connection cables
E14	Low pressure error	Pressure below minimum threshold (not present in ACT mode)	Check the settings of parameters P45 and P46
E15	Loss of phase error	One of the three power supply phases is missing (three-phase versions only)	Check the connection to the power supply network
E30	Multi-pump protocol error	Incompatible multi-pump protocol	Bring all the units to the same firmware version

See also Par. 6.3.2 and Par. 6.4.3.

9 Technical Data



Table 16: Electrical, Environmental and Installation specifications

	e-SM Drive model										
	103	105	107	111	115	303	305	307	311	315	322
Input											
Input frequency [Hz]	50/60 ± 2										
Main supply	LN					L1 L2 L3					
Nominal input voltage [V]	208-240 ±10%					208-240 / 380-460 ±10%					380-460 ±10%
Maximum current absorbed (AC) in continuous service (S1) [A]	See data plate										
PDS Efficiency Class	IES2										
Output											
Min.-Max. Speed [rpm]	800-3600										
Leakage Current [mA]	< 3,5										
I/O auxiliar + 15VDC power supply [mA]	I _{max} < 40										
Fault signal relay	1 x NO V _{max} < 250 [VAC] , I _{max} < 2 [A]					1 x NO V _{max} < 250 [VAC] , I _{max} < 2 [A]					
Motor status relay	-					1 x NO V _{max} < 250 [VAC] , I _{max} < 2 [A]					
EMC (Electro Magnetic Compatibility)	See Par. Declarations. Installations must be performed in accordance with the EMC good practice guidelines (e.g. avoid "eyebolts" on the transmission side)										
Sound pressure L _{pA} [dB(A)] @ [rpm]	< 62 @3000 < 66 @3600										
Insulation class	155 F										
Protection class	IP 55, Enclosure Type 1 Protect the product from direct sunlight and rainfall										
Relative humidity (storage & operating)	5%-95% UR										
Storage temperature [°C] / [°F]	-25-65 / -13-149										
Operating temperature [°C] / [°F]	-20-50 / -4-122										
Air Pollution	Pollution Degree 2										
Installation altitude a.s.l. [m] / [ft]	< 1000 / 3280 Derating may occur at higher altitudes										

9.1 Dimensions and weights

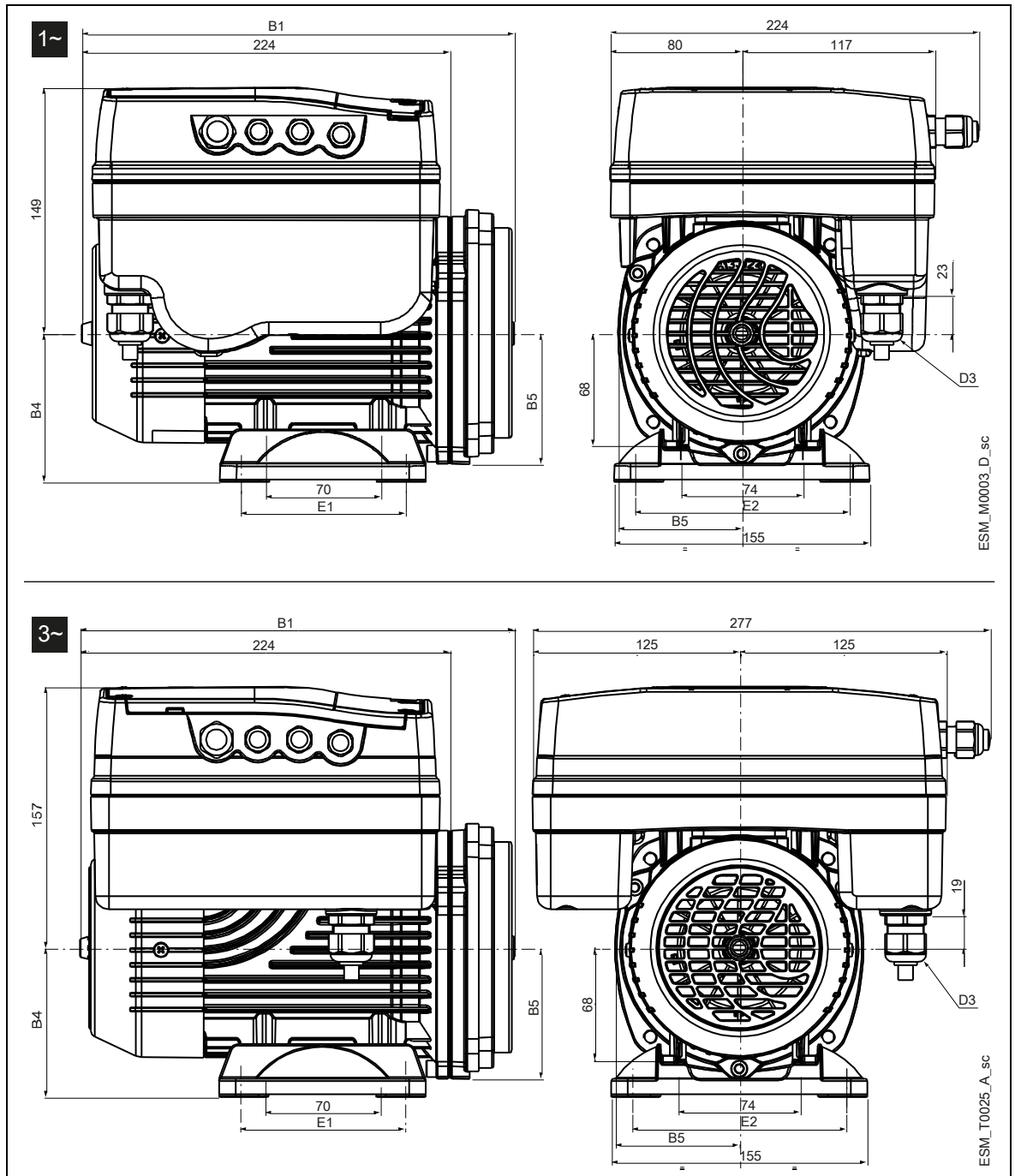

Figure 19: Dimensions

Table 17: Dimensions and weights

Model			Net weight (motor + drive) [kg]					B1	B4	B5	D3	E1	E2
			1~		3~			[mm]					
			103 105 107	111 115	303 305 307	311 315	322						
ESM90R...LNEE			7.4	8.9	13	14.4	16	376	-	79	M20	-	-
ESM90RS8...LNEE			7.3	8.8	12.8	14.2	15.8	343	-	79		-	-
ESM90R...B14-SVE			7.5	9	13.1	14.5	16	292	-	79		-	-
ESM90R...B5			7.5	9	13.1	14.5	16	292	-	100		-	-
ESM80...HMHA	80...HMHA US	80...HMHA EU	7.5	9	13	14.5	16	263	90	79		100	125
ESM80...HMHB	80...HMHB US	80...HMHB EU	7.6	9.2	13.2	14.6	16.1	268	90	80		100	125
ESM80...HMVB	80...HMVB US	80...HMVB EU	7.4	8.9	13	14.4	16	268	-	80		-	-
ESM80...HMHC	80...HMHC US	80...HMHC EU	7.9	9.4	13.4	14.8	16.4	272	90	91		100	125
ESM80...HMVC	80...HMVC US	80...HMVC EU	7.6	9.1	13.2	14.6	16.2	272	-	91		-	-
ESM80...BG			7.3	8.8	12.9	14.3	15.9	282	-	108		-	-
ESM90R...56J			7.5	9.1	13	14.5	16.1	307	89	83	NPT 1/2"	76	124
ESM90R...56C			7.2	8.8	12.6	14.3	15.8	294	-	83		-	-

... = 103, 105, 107, 111, 115, 303, 305, 307, 311, 315, 322
 - = motor foot not found

10 Declarations

10.1 EC Declaration of Conformity (Original)

Xylem Service Italia S.r.l., with headquarters in Via Vittorio Lombardi 14 - 36075 Montecchio Maggiore VI - Italy, hereby declares that the product:

Electric pump with integrated variable speed drive, pressure transmitter and 2 metre cable for the transmitter (see adhesive on the first page)

fulfils the relevant provisions of the following European Directives:

- Machinery 2006/42/EC (ANNEX II - natural or legal person authorised to compile the technical file: Xylem Service Italia S.r.l.)
- Eco-design 2009/125/EC, Regulation (EU) no. 547/2012 (water pump) if MEI marked, and the following technical standards
- EN 809:1998+A1:2009, EN 60335-1:2012+A11: 2014, EN 60335-2-41:2003+A1:2004+A2:2010, EN 62233:2008
- EN 50598-1:2014, EN 50598-2:2014+A1:2016

Montecchio Maggiore, 22/02/2017

Amedeo Valente
(Director of Engineering and
Research & Development)
rev.02



10.2 EU Declaration of Conformity (No EMCD19)

1. Apparatus model/Product:
see adhesive on the first page
2. Name and address of the manufacturer:
Xylem Service Italia S.r.l.
Via Vittorio Lombardi 14
36075 Montecchio Maggiore VI
Italy
3. This declaration of conformity is issued under the sole responsibility of the manufacturer.
4. Object of the declaration:
Electric pump with integrated variable speed drive, pressure transmitter and 2 metre cable for the transmitter (see adhesive on the first page)
5. The object of the declaration described above is in conformity with the relevant Union harmonisation legislation:
Directive 2014/30/EU of 26 February 2014 (electromagnetic compatibility)
6. References to the relevant harmonised standards used or references to the other technical specifications, in relation to which conformity is declared:
EN 60730-1:2011, EN 61800-3:2004+A1:2012 (Category C2),
EN 55014-1:2006+A1:2009+A2:2011, EN 55014-2:1997+A1:2001+A2:2008, EN 61000-6-2:2005, EN 61000-6-3:2007+A1:2011
7. Notified body: -
8. Additional information: -

Signed for and on behalf of: Xylem Service Italia S.r.l.
Montecchio Maggiore, 22/02/2017
Amedeo Valente
(Director of Engineering and R&D)
rev.01



Lowara is a trademark of Xylem Inc. or one of its subsidiaries.

Xylem Service Italia S.r.l.
Via Vittorio Lombardi 14
36075 – Montecchio Maggiore (VI) - Italy
www.xylem.com/brands/lowara

Lowara is a trademark of Xylem Inc. or one of its subsidiaries.
© 2018 Xylem, Inc.



**Brown Brothers
Engineers
Australia Pty Ltd**
1300 4 BBENG
www.brownbros.com.au



**Brown Brothers
Engineers Ltd**
0508 4 BBENG
www.brownbros.co.nz