



Flygt compact mixers

RELIABLE VERSATILITY, HIGH EFFICIENCY



Compact mixing for any requirement

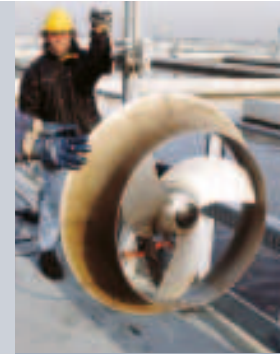

Advantages of Flygt compact mixers

- High efficiency and reliability
- Space-saving installation
- Easy handling of highly fibrous materials
- Few, easy-to-service components
- Durable design
- Low total cost of ownership

Rising to the mixing challenge

All mixing applications require varying degrees of both small-scale turbulence and bulk flow. With a good bulk flow, the contents of the entire tank are set into motion involving in the mixing process. The strength of the bulk flow is, in turn, dependent on the total amount of installed thrust and layout.

Unparalleled expertise, broad mixing solutions

Flygt pioneered the use of thrust as the main performance parameter for mixing. And every day, we put more than 50 years of R&D expertise and practical experience to work to determine the right technology, mixer size and layout for your requirements.

Our comprehensive portfolio of mixers and agitators cover virtually every requirement. Hundreds of thousands of Flygt mixers and agitators are in service worldwide, delivering efficient mixing performance.

Flygt compact mixers

Engineered for flexibility, versatility and lean installation, these space-saving mixers offer highly efficient solutions for any tank shape and size.

Our compact mixers easily blend highly contaminated fluids high-density or high-viscosity liquids, and liquids with fibrous material. Few components, low capital investment and straightforward service routines make Flygt compact mixers the economical choice for a broad range of mixing applications, like:

- Activated sludge treatment such as conventional ASP or sequencing batch reactor
- Sludge holding tanks
- Equalization tanks
- Pump station mixing
- Grit chamber mixing
- Chlorination basins
- Paper pulp chests
- Quenching tanks



Our comprehensive mixing portfolio

Flygt's wide array of reliable, trouble-free mixing equipment includes:

- Flygt low-speed mixers
- Flygt compact mixers
- Flygt top-entry agitators
- Flygt jet mixers
- Flygt hydroejectors

Designed for high reliability

For decades, we have been at the cutting edge of mixer research and development. Flygt compact mixer components contribute to reliable operation, reduced energy costs and efficient mixing.

Compact, robust direct-drive motor

Our squirrel-cage induction motor is manufactured at our premises for durability and dependability. Stator windings are trickle impregnated in resin and rated at Class H 180°C (355°F) for excellent resistance to overheating and long service life.



Class H stator motor for long service life.

Line-start permanent magnet motor

The optional line-start permanent magnet (LSPM) motor for the Flygt 4650 compact mixer combines the efficiency of a synchronous permanent magnet motor with the direct on-line starting of an induction motor. This saves on current-related costs, such as for cables and power supplies, for additional energy savings.



Optional LSPM motor for additional energy savings.

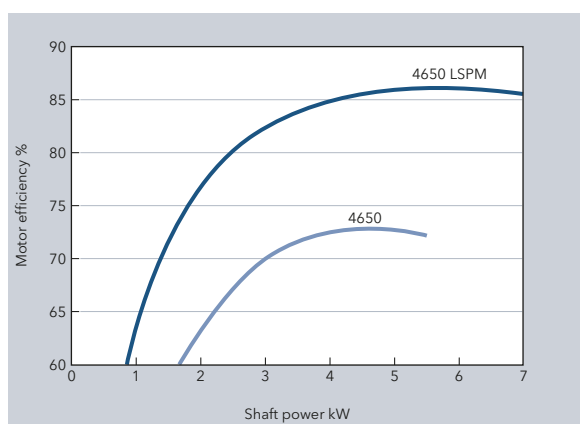

and up to 20% on energy compared to conventional induction motors.

Oil housing

The large oil volume ensures smooth operation and long service intervals between refills. To make service easy, the oil plugs allow refill without removing the propeller.

Active Seal™ for zero leakage

The Flygt Plug-in seal features the Active Seal™ system for zero leakage into the stator housing. Laser-cut grooves on the inner seal faces, act as a micro-pump to force any liquid present on the drive-unit back to the buffer fluid side. The seal housing with barrier fluid helps lubricate and cool the seal, ensuring efficient heat transfer even when running dry.



Active Seal™ for zero leakage.

Non-clogging, fiber-handling hydraulics

Flygt compact mixers feature an efficient hydraulic design with few, easy-to-service components, which contributes to reliable, trouble-free operation. Engineered to generate maximum thrust with minimal use of energy, the propeller blades with their backswept design allow highly fibrous material to pass through. Wide-hub design deflects fibrous material.



Non-clogging hydraulics

Jet ring for higher efficiency

With the optional jet ring, it is possible to achieve an increase in mixer efficiency by up to 15% in water - and even higher in viscous media, while further reducing energy consumption.



Optional jet ring for increased mixing efficiency.

Dependability starts with attention to detail

1 Cable entry

Compressible bushing and strain relief on the cable prevent leakage into the motor, providing a reliable installation.

5 Motor

High-performance, squirrel-cage induction Class H motor provides thermal overload protection and extra long service life.

2 Oil housing

Large barrier fluid volume lubricates and cools the seal and thereby prolongs service life.

6 Propeller

Available with different blade angles, thin double-curved propeller optimizes mixing efficiency. Wide-hub design deflects fibrous material.

3 Monitoring

Thermal sensors embedded in the stator windings prevent overheating. Leakage sensors are available as options.

4 Bearings

Securely supports the shaft by means of one main bearing at the propeller end and a double bearing at the rear end.

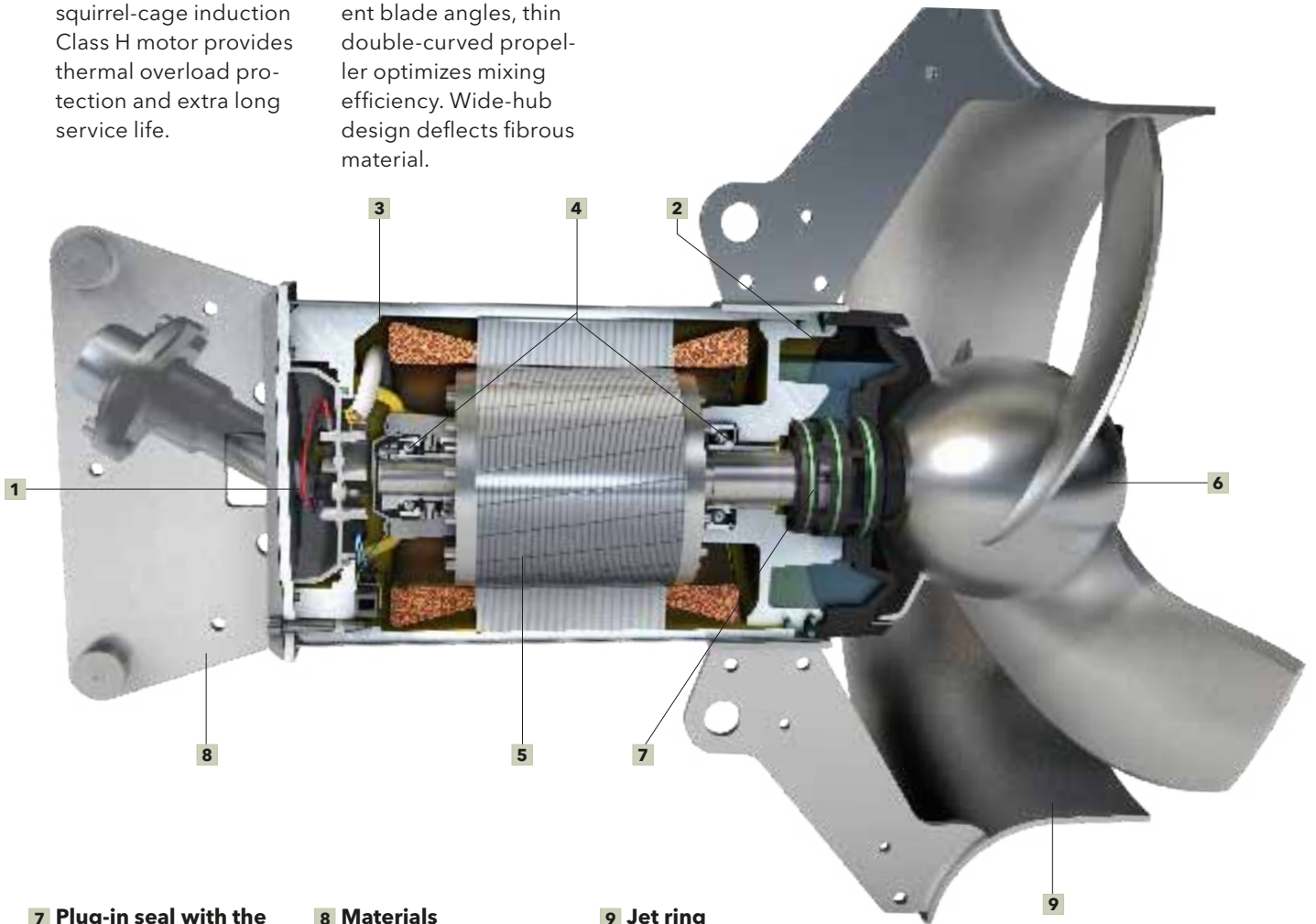

7 Plug-in seal with the Active Seal™ system

Offers increased sealing reliability and zero leakage into the motor, thereby reducing the risk of bearing and stator failure.

8 Materials

All external parts manufactured for excellent corrosion-resistance. Major parts in stainless steel.

9 Jet ring

Optional jet ring increases hydraulic efficiency thereby reducing power consumption.

Low-cost installation

Flygt installation equipment is rigid enough to withstand the weight and reaction forces exerted by the mixer throughout its operating life. It is also robust and easy to work with.

Guide bar systems for any tank

To help withstand fatigue from strongly fluctuating forces within the tank, Flygt compact mixers are usually installed along rigid guide bars at appropriate depths for optimal mixing efficiency. Used together with our lifting equipment, guide bar systems enable easy access for inspection and service.

Safe, convenient lifting equipment

Raising and lowering Flygt compact mixers with our lifting equipment is as easy and convenient as it is safe. The CE-approved lifting davit is mounted in a holder at its lower end, which enables easy turning of the davit. To reduce investment cost, one davit can be used for several mixers.

Methods of installation

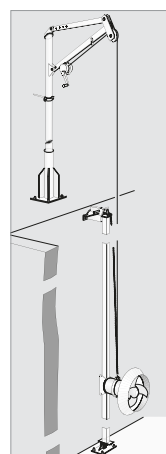

Guide bar mounting
The mixer is lowered or raised along a guide bar located on the tank wall.

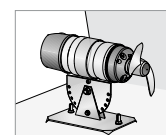

Floor mounting
Affixes to a stand on the bottom; often used in shallow tanks and ponds.

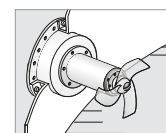

Flange mounting
Securely affixes to an adapter flange, which is mounted in the tank inspection hole.

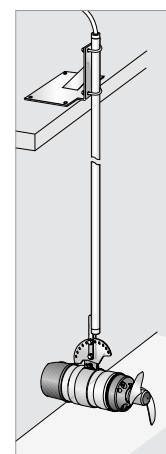

Cantilever mounting
Mounts on a cantilever bar, which is fixed to the tank edge.

A broad range of compact mixers

Our compact mixer portfolio includes eight different sizes of direct drive mixers. Using standardized materials and components, the modular design, which includes a series of blade angles for each model, provides a comprehensive range of mixer performance.

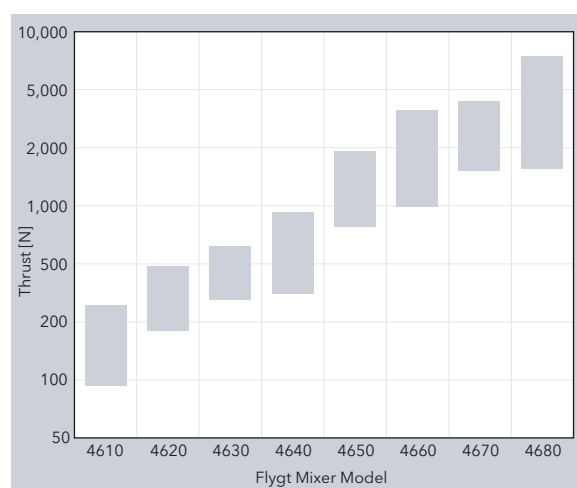

Facts and figures

Model	4610	4620	4630	4640	4650	4660	4670	4680	4650 LSPM				
Power, kW	0.9	1.5	1.5	2.5	3.7	5.5	7.5	10	13	18.5	25	5.0	7.0
· 50 Hz													
· 60 Hz (hp)	0.9(1.2)	1.7(2.3)	1.9(2.5)	3.0(4.0)	4.5(6.0)	6.2(8.3)	8.2(11.0)	11.2(15.0)	14.9(20.0)	22.4(30.0)	30.0(40.0)	6.0(8.0)	8.2(11.0)
Thrust range													
· 50 Hz, N	100-200	100-300	200-500	200-800	800-1300	800-1900	800-2200	800-2800	1400-3800	1400-5300	1400-6400	900-1400	900-2000
· 60 Hz, N	100	100-300	300-500	300-800	1200	1200-1500	1200-2300	1200-3100	2000-3800	2000-5500	2000-7000	1200-1600	1200-2400
Propeller diam, m (in)	0.210 (8.3)	0.210 (8.3)	0.368 (14.5)	0.368 (14.5)	0.580 (22.8)	0.580 (22.8)	0.580 (22.8)	0.580 (22.8)	0.766 (31.6)	0.766 (31.6)	0.766 (31.6)	0.580 (22.8)	0.580 (22.8)

Options

SUBCAB®

Heavy-duty submersible rubber cable.

SUBCAB® Screened

Heavy-duty submersible rubber cable for use with VFD and to limit electromagnetic interference.

Special cables

Withstand high temperatures, high voltage and chemical agitation.

Leakage sensors

Automatically detect, together with external monitoring equipment, any leakage in stator and oil housings.

Extended jet ring

For improved motor cooling in viscous liquids.

Flygt MiniCAS supervision

Provides quick and easy equipment protection by monitoring thermal overload switches and leakage detectors.

Explosion-proof versions

For use in potentially explosive or flammable environments.

High chromium cast iron propeller

Withstands severe abrasion resulting from mixing hard mineral slurries.

Silicone carbide (RSiC) seal

Provides excellent abrasion resistance and superior resistance against acid and chloride liquids.

Vortex protection shield

Prevents air vortices from being drawn from the surface into the mixer propeller to maintain optimal performance. For use in applications where the liquid depth is very shallow or when the mixer must be placed close to the surface.

Warm liquid versions

For use in high temperature applications (up to 90°C).

Zinc anode kits

Provides extra corrosion-resistance for seawater applications.



Stator leakage sensor



Flygt MiniCAS supervision unit



Vortex protection shield



Cast iron propeller



Extended jet ring

A perfect blend of support and service



Boost efficiency with monitoring and control

We supply everything from controllers, sensors and start equipment to SCADA software for complete fluid handling supervision.



A deep understanding of fluid handling and vast experience in mixing technologies makes Flygt a trustworthy and reliable partner for all your process requirements.

Systems engineering expertise

Dimensioning and layout are critical factors in maximizing performance. Using our expertise and intelligent tools, we analyze your requirements to identify the right mixer or agitation system to optimize your processes.

Support along the way

Our recommendations result from the use of specially developed and validated Computational Fluid Dynamics software programs, based on carefully selected, relevant models. Our own testing facilities as well as field testing and measurement of actual performance onsite provide Flygt engineers with keen insight into what works. Using this knowledge and expertise we help you maintain your installation in top operating condition.

Global service network

Should any problem occur with your Flygt mixers and agitators, professional assistance and original spare parts are always within easy reach through our extensive service network in 140 countries.



Enjoy the benefits of a premium brand

Genuine spare parts are vital to ensure long and trouble-free operation. We guarantee the availability of spare parts for 10 years after we stop production of a model.

Xylem ['zīləm]

- 1) The tissue in plants that brings water upward from the roots
- 2) A leading global water technology company

We're 12,000 people unified in a common purpose: creating innovative solutions to meet our world's water needs. Developing new technologies that will improve the way water is used, conserved, and re-used in the future is central to our work. We move, treat, analyze, and return water to the environment, and we help people use water efficiently, in their homes, buildings, factories and farms. In more than 150 countries, we have strong, long-standing relationships with customers who know us for our powerful combination of leading product brands and applications expertise, backed by a legacy of innovation.

For more information on how Xylem can help you, go to xylem.com.



Flygt is a brand of Xylem. For the latest version of this document and more information about Flygt products visit www.flygt.com

